

9.33i, 9.35i Treadmill

Warning: This service manual is for use by Precor trained service providers only. If you are not a Precor Trained Servicer, you must not attempt to service any Precor Product; Call your dealer for service.

This document contains information required to perform the majority of troubleshooting, and replacement procedures required to repair and maintain this product.

This document contains general product information, software diagnostic procedures (when available), preventative maintenance procedures, inspection and adjustment procedures, troubleshooting procedures, replacement procedures and electrical block and wiring diagrams.

To move directly to a procedure, click the appropriate procedure in the bookmark section to the left of this page. You may “drag” the separator bar between this page and the bookmark section to change the size of the page being viewed.

Section One - Things you Should Know

About This Appendix

Section One, Things You Should Know. This section includes technical specifications. Read this section, as well as the 9.33i or 9.35i Treadmill Owner's Manual, before you perform the maintenance procedures in this manual.

Section Two, Software Features. Precor treadmills are programmed with several diagnostic and setup features. This section contains the procedures you need to access the diagnostic features on this treadmill.

Section Three, Checking Treadmill Operation. This section provides you with a quick way of checking treadmill operation. Check treadmill operation at the end of a maintenance procedure and when it is necessary to ensure that the treadmill is operating properly.

Section Four, Inspection and Adjustment Procedures. Perform inspection procedures when a trouble symptom points to a particular problem and after removing and replacing major components. Many maintenance problems can be fixed by adjusting various treadmill components. This section also provides you with the step-by-step procedures required to make these adjustments.

Section Five, Troubleshooting Procedures. The diagnostic and troubleshooting procedures contained in this section should be performed when it is necessary to isolate a problem to a particular component.

Section Six, Replacement Procedures. When a treadmill component must be replaced, go to this section and follow the step-by-step procedures required to remove and replace the component.

Section Seven, Technical Diagrams and Parts Lists. This section includes wiring diagrams, and block diagrams for the 9.33i and 9.35i Treadmill.

General Information

For the latest exploded view diagram, part number and part pricing information, visit the Precor dealer website at "www.precor.com/connection".

Technical Specifications

Physical Specifications

Length:	79 inches (201 cm.)
Width:	33.5 inches (85 cm.)
Height:	55 inches (140 cm.)
Running surface:	20 inches by 57 inches (51 cm. by 145 cm.)
Motor:	2.75 (9.33i), 3.0 (9.35i) hp. continuous duty DC
Speed:	0.5 to 11 mph (0.8 to 18 kph) 10 mph is equivalent to a 6 minute mile
Incline:	0% to +15% grade
Power:	120 Vac 50/60 Hz @ 20 amp
Weight:	280 lbs (127 kg.)

Procedure 2.1 - Accessing the Hardware Validation Program

The treadmill's diagnostic program consists of the following modes:

- Display Test
- Keyboard Test
- Heart Rate Test
- Lift Test
- Belt Speed Test
- Belt Power Test

Procedure

1. Plug the power cord into the wall outlet, then turn on the treadmill with the circuit breaker.
2. Refer to diagram 2.1 below and press keys **STOP,5,1,7,6,5,7,6,1**, sequentially. On the 9.35i either the function keys or the numerical keypad may be used.
3. The display will momentarily read **DISPLAY TEST** and then illuminate every LED on the display. Check all LED positions to ensure that all of the LED's are functioning. Press the **ENTER** key to continue.

Diagram 2.1 - 9.35i Display



4. The display will momentarily read **KEYBOARD TEST**.
5. The keyboard test will place two dots on the display for each key on the display, including the numeric keypad. Pressing a key will cause the upper of the two dots associated with the key to go out. Test all of the keys in this manner. Tug on the safety key lanyard, to ensure that the **STOP** key is activated.
6. Press and hold the **ENTER** key to proceed to the heart rate test.
7. The display will momentarily read **HEART RATE TEST**.
8. The heart rate test will display the heart rate being received during this test from either a chest strap transmitter or test transmitter.
9. Three heart rate values will be displayed. They will be prefixed “U” for unfiltered, “F” for filtered and “P” for Polar filtering. The Polar filtered heart rate will also appear in the normal heart rate display, since Polar filtering is the filtering used during normal operation. The right most red LED in the smart rate display will flash each time a heart beat is detected.

Note: If there is not a heart rate receiver installed or there is a bad or intermittent connection between the heart rate receiver and the upper PCA, the messages in step 9 will be replaced by the message **NO HEART RATE RECEIVER**.

10. Press the **ENTER** key to proceed to the lift test.
11. The display will momentarily read **LIFT TEST**.
12. Two numbers will be displayed, the percent of lift and A/D number related to the current lift position. The A/D (analog to digital) number represents the lift potentiometer reading. The A/D number will be in the range of 0 to 255.
13. The lift may be operated using the **INCLINE** keys. The incline percentage and A/D numbers will change accordingly.
14. The A/D reading will be used later in this service manual to calibrate the lift.
15. Press the **ENTER** key to proceed to the belt speed test.
16. The display will momentarily read **BELT SPEED TEST**.
17. The speed of the running belt is controlled by the **SPEED** keys during this test.
18. The following values are displayed; time (that the running belt has operated during this test), current (in amps through the drive motor), belt speed (in MPH) and power bits (PWM value).
19. This test is valuable in diagnosing treadmill load conditions such as running bed and/or running belt condition. As load is increased, the speed is kept at a constant value (as set via the **SPEED** keys) and the current and power bits will vary proportionately to the load.

20. It is suggested that you perform this test on a treadmill known to be in excellent operating condition. Note the values displayed at a fixed speed (such as 3 MPH) and your body weight. Those values may then be used to benchmark the operation of treadmills you are diagnosing.
21. Press the **Stop** or **ENTER** key to exit the diagnostics routine.

Procedure 2.2 - Accessing the Information Display Program

The information display will access the following data;

- Odometer
- Hour meter
- Software version
- Error log

Procedure

1. Plug the power cord into the wall outlet, then turn on the treadmill with the circuit breaker.
2. Press the keys **STOP,6,5**, sequentially.
3. The display will momentarily read, **ODOMETER**.
4. The treadmill's odometer will be displayed as **1234567 MPH** or **1234567 KPH**.

Note: The odometer data is stored in non-volatile memory on the upper PCA. If the upper PCA is replaced the odometer data will be lost.

5. Press the **ENTER** key to proceed to the hour meter display.'
6. The display will momentarily read, **HOOR METER**.
7. The operating time of the unit will be displayed as **12345 HOURS**. The operating time is defined as total amount of time that the unit has operated in program modes with the drive motor running. The hour meter is also used to provide the "time stamp" for the error code log.
8. Press the **ENTER** key to proceed to the software version display.
9. The display will momentarily read, **SW VERSION**.
10. The **▲,▼** keys will scroll through the software versions. The software versions will be displayed as; **UPPER APP SOFTWARE XX.X, UPPER BOOT SOFTWARE** and **LOWER SOFTWARE XX.X**.
11. Press the **ENTER** key to proceed to the error log.
12. The error log will store up to 10 error conditions. The errors are logged with the most recent error in position one. When a new error condition occurs, each existing error is pushed down one position in log. If there was an error in position 10 when a new error was logged, the error that was in position 10 will be lost.

13. Each error in the log will show the odometer reading (in miles) and the time (hour meter) when the error occurred. The errors are displayed as;
1 ER20 1234567 MI 12345 HRS.
14. The arrows keys will allow you to scroll through the log. When the first unused position is reached in the log, the message **NO MORE ERRORS** will be displayed.
15. When the **QUICK START** key is held for 2 seconds the message **HOLD TO CLEAR ERRORS** will be displayed. If the **QUICK START** key is held for an additional 2 seconds, the message **CLEARED** will be displayed. When the **QUICK START** key is released the message **NO MORE ERRORS** will be displayed and all error are erased from the log.
16. Press the **STOP** or **ENTER** key to exit the information display.
17. Note: the error log can also be entered at any time by pressing and holding the **RESET** key for four seconds.

Procedure 2.3 - Accessing the User Parameter Program

This procedure allows you to change the following settings:

- Set Measurement Units
- Enable/Disable Password
- Set User Name

Procedure

1. Plug the power cord into the wall outlet, then turn on the treadmill with the circuit breaker.
2. Press keys **STOP,5,6,7,1** sequentially.
3. The display will momentarily read **SELECT UNITS**
4. The currently selected measurement unit will then be displayed.
5. Use the **▲,▼** keys to toggle between **U.S STANDARD** and **METRIC..**
6. Press the **ENTER** key to select the currently displayed measurement unit.
7. The display will momentarily read, **PASSWORD**
8. Use the **▲,▼** keys to select either **PASSWORD ENABLED** or **PASSWORD DISABLED.**
9. Press the **STOP** or **ENTER** key to exit the program.

Procedure 2.4 - Documenting Software Problems

When a problem is found with the software in the upper or lower PCA, record the information listed below.

When a problem occurs, record the following information:

- Model and serial number
- Software version number

- Program number running when the problem occurred
- A description of:
 - a. What happened or failed to happen.
 - b. The action taken by the user just before the problem occurred.
 - c. Problem-related information (such as how far into the program the problem occurred, the work level being used when the problem occurred, etc.).

- The frequency of occurrence.

Section Three - Checking Treadmill Operation

This section provides you with a quick method of checking treadmill operation. Check treadmill operation at the end of a maintenance procedure and when it is necessary to ensure that the treadmill is operating properly.

Procedure

4. Plug the power cord into the wall outlet, then turn on the treadmill with the circuit breaker.
5. Place the treadmill in Manual Mode. Adjust the speed of the running belt to 2–3 m.p.h. Operate the treadmill for at least 5 minutes.
 - a. Concentrate on the feel of the running belt and the sound of the drive motor and rollers. Be on the alert for unusual noises, smells, or vibrations.
 - b. Log the power bits under loaded and unloaded conditions.
 - c. Observe the LED's on the electronic console. Make sure that each LED lights as the information corresponding to that LED is displayed on the electronic console.
3. If during step 1c, squeaking noises associated with the running deck were heard, check the lubrication of the running deck studs. If necessary, apply silicon grease to all of the running deck studs.
3. Press the **STOP** key. When the treadmill comes to a stop, view the electronic console as the treadmill scans time, speed, distance and percent of lift.
4. Press the **INCLINE ▲** key while viewing the electronic console. Confirm that the running bed inclines and the incline display increments to 15% as the **INCLINE ▲** key is pressed.
5. Press the **INCLINE ▼** key while viewing the electronic console. Confirm that the running bed returns to a level position and the incline display decrements to 0% as the **INCLINE ▼** key is pressed.
6. Turn off the treadmill with the circuit breaker, then unplug the treadmill from the wall outlet.

Procedure 4.1 - Calibrating the Lift Motor

1. Set the treadmill circuit breaker in the “off” position and unplug the line cord from the wall outlet.
2. Remove the hood.
3. Place the treadmill on it’s right side. Remove hitch and clevis pins that secure the lift tube to the lift platform.

Diagram 4.1 - Lift Motor Mounting

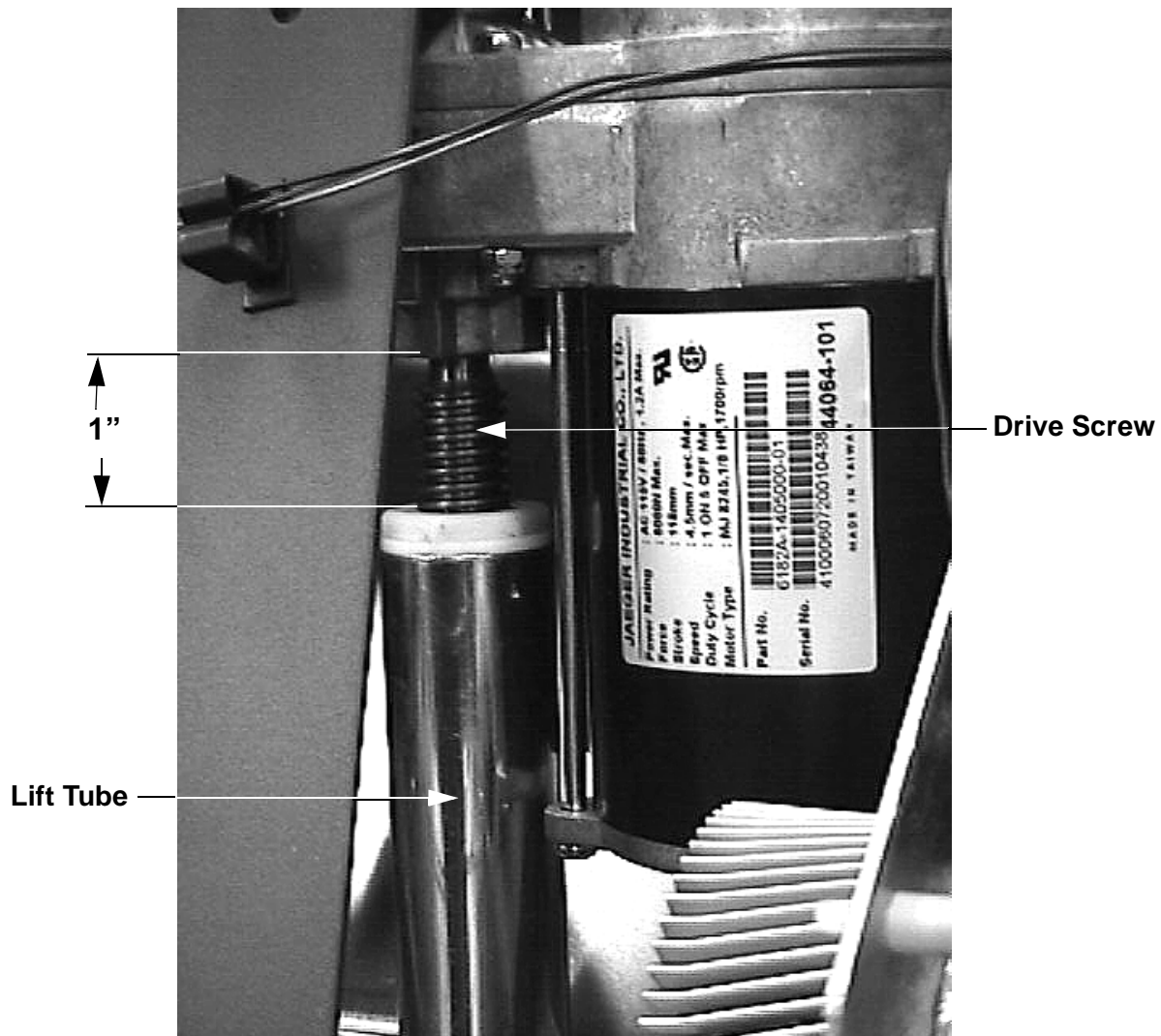

4. Plug the power cord into the wall outlet, set the treadmill circuit breaker in the “on” position.
5. Press keys **RESET, 5,1,7,6,5,7,6,1**, sequentially to enter the diagnostics routine. Refer to Procedure 2.1 and advance to the lift test. When the lift calibration number is displayed on the console, use the **INCLINE ▲** or **INCLINE ▼** key to set the lift calibration number to 20.

CAUTION

While running the lift motor in the diagnostics mode it is possible to operate the lift motor beyond its normal range of motion. When you perform the next step, care must be taken not to jam the lift tube against the motor frame.

6. Press the **RESET** key to exit the diagnostics mode.
7. Set the treadmill circuit breaker in the “off” position, unplug the line cord from the wall outlet.
8. Rotate the lift tube clockwise, by hand, as far as possible. Then rotate the lift tube counter-clockwise until the distance from the top of the lift tube to the lift motor is 1 inch. See Diagram 4.1. While rotating the lift tube, be sure the lift motor drive screw does not rotate. If the drive screw is rotated, return to step 4 and repeat steps 4 through 7.
9. Replace the clevis and hitch pins removed in step 3. Return the treadmill to an upright position.
10. Plug the line cord into the wall outlet, set the treadmill circuit breaker in the “on” position.
11. check the calibration of the lift system by performing the following steps:
 - a Press the **INCLINE ▲** key until the console displays 15% incline.
 - b Press the **INCLINE ▼** key to return to 0% incline.
12. Re-install the hood per Procedure 6.11.

Procedure 4.2 - Adjusting Drive Belt Tension

1. Set the treadmill circuit breaker in the “off” position and unplug the line cord from the wall outlet.
2. Remove the hood.
3. Place the drive belt tension gauge on the drive belt as shown in Diagram 4.2.

Diagram 4.2 - Drive Belt Tension Gauge



4. The gauge should read approximately 80 inch/pounds. The drive belt tension is acceptable if it is in the range of 70 to 90 inch-pounds.
5. If the drive belt tension is less than 70 or greater than 90 inch/pounds, slightly loosen the four drive motor mounting bolts. The drive motor mounts on slotted holes allowing the drive motor to be move forward or rearward. Move the drive motor forward or rearwards, as required, until the belt gauge reads approximately 80 inch/pounds and tighten the four drive motor mounting bolts. See Diagram 4.3. Momentarily remove the drive belt tension gauge from the drive belt. Replace the drive belt tension gauge on the drive belt and re-adjust the drive belt tension, if necessary. Torque the four drive motor mounting bolts to 180 inch pounds.

6. Re-install the hood per Procedure 6.11.

Diagram 4.3 - Drive Belt Adjustment



**Drive Motor
Mounting Bolt**

7. Plug the line cord into the wall outlet and set the treadmill circuit breaker in the “on” position.
8. Check treadmill operation per Section 3.

Procedure 4.3 - Treadmill Belt Cleaning

Procedure:

1. First, check for proper operation of the safety stop key. Stand to one side of the treadmill. Insure that the stop key tether is hanging straight down from the stop key and is not wrapped around the handle bars. Push the "Quick Start" button and wait for the display to count down and for the running belt to begin moving. Once the running belt is moving pull the safety stop key tether. **See the illustration below.**

CAUTION: If the running belt does not stop, turn off the power using the ON/OFF switch at the front of the treadmill and unplug the power cord. The treadmill must remain out of service until the stop switch is repaired.
If the running belt stops, continue with the cleaning procedure.

2. A clean, dry towel approximately 36 inches or 1 meter in length is required. Fold the towel in half lengthwise, lift the running belt up and insert the towel beneath the belt so that an end of towel extends on to each deck trim. **See the illustration below.**



3. Stand to one side of the treadmill, push the "Quick Start" button, grasp the towel as illustrated in the illustration above. **Note:** You will have 3 seconds to firmly grasp your hands on the towel before the treadmill running belt begins to move. Allow the treadmill to run for about one minute while holding the towel firmly in place.

CAUTION: If the towel becomes loose it may be pulled into the treadmill's rollers. Pull the safety key tether to stop the treadmill and retrieve the towel, no damage should occur. Start the procedure over again.
See the illustration below.

4. Keep one hand firmly grasped on the towel, use your other hand to pull on the safety stop key tether to stop the treadmill running belt. **See the illustration below.**

5. Turn the power off. Place your hands on the towel and push it up and down the length of the running deck several times to clean the deck.
6. Remove the towel.

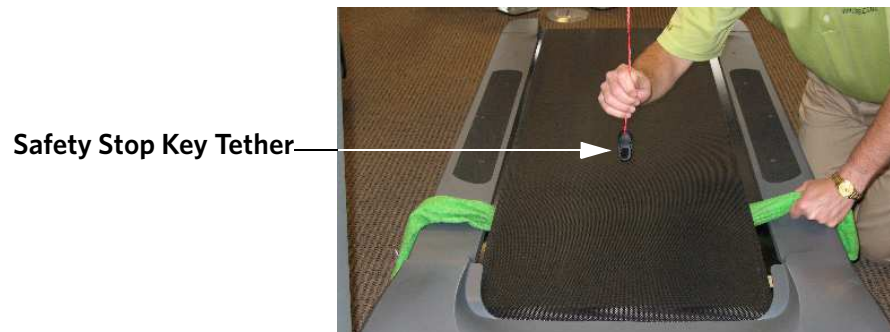

It is recommended that this procedure be performed frequently to extend the life of the running belt and running deck.

Procedure 5.1 - Troubleshooting the Keypad and Upper PCA

If the function keys on the electronic console are unresponsive, the problem may be either the upper PCA or keypad. The keys on this unit are touch sensitive keys. It is necessary to use the keypad diagnostics to troubleshoot the key functions.

Procedure

1. Set the circuit breaker in the “off” position.

WARNING

Before continuing with this procedure, review the Warning and Caution statements listed in Section One of the Commercial Treadmill Service Manual.

2. If the treadmill powers up and functions normally until a particular key(s) is pressed, skip to step 13.
3. If an Error 5 “key depressed” message is immediately displayed when the treadmill is powered up, continue with the next step.
4. This condition may be caused by either the keypad or upper PCA. Set the circuit breaker in the “off” position. Reach under the display console and disconnect the interconnect cable. See Diagram 5.1.

Diagram 5.1 - Display Console (Bottom View)

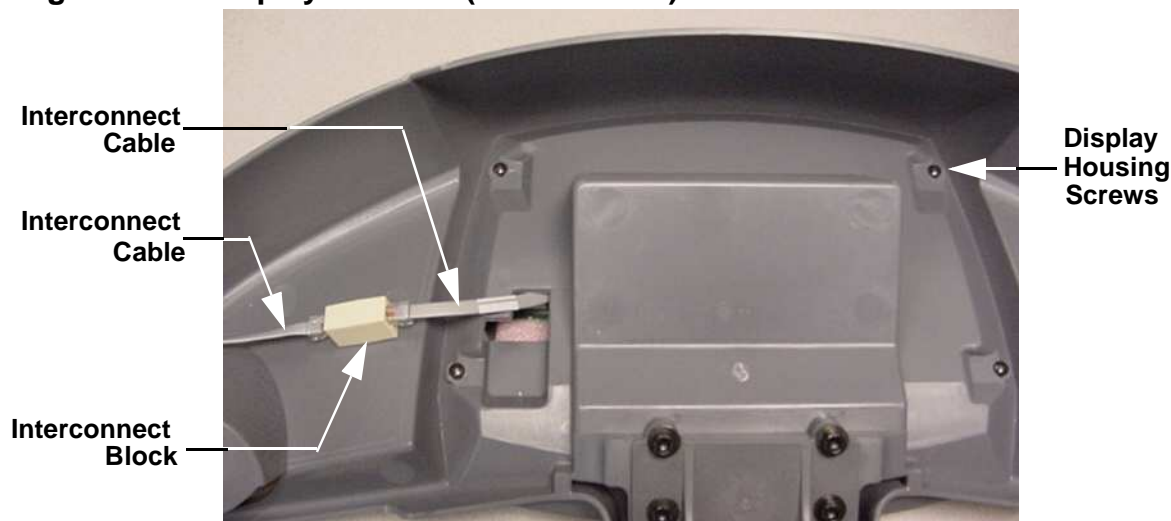

5. Remove the four screws that fastens the display housing front panel to the display console. These screws are located on the rear of the display console.

6. Carefully, lift the display housing front panel off of the display housing backing plate. Disconnect the interconnect cable, heart rate cable and stop switch cable from the upper PCA.
7. Disconnect the keypad cable from the upper PCA. See Diagram 5.2.

Diagram 5.2 - 9.35i Upper PCA & Keypad

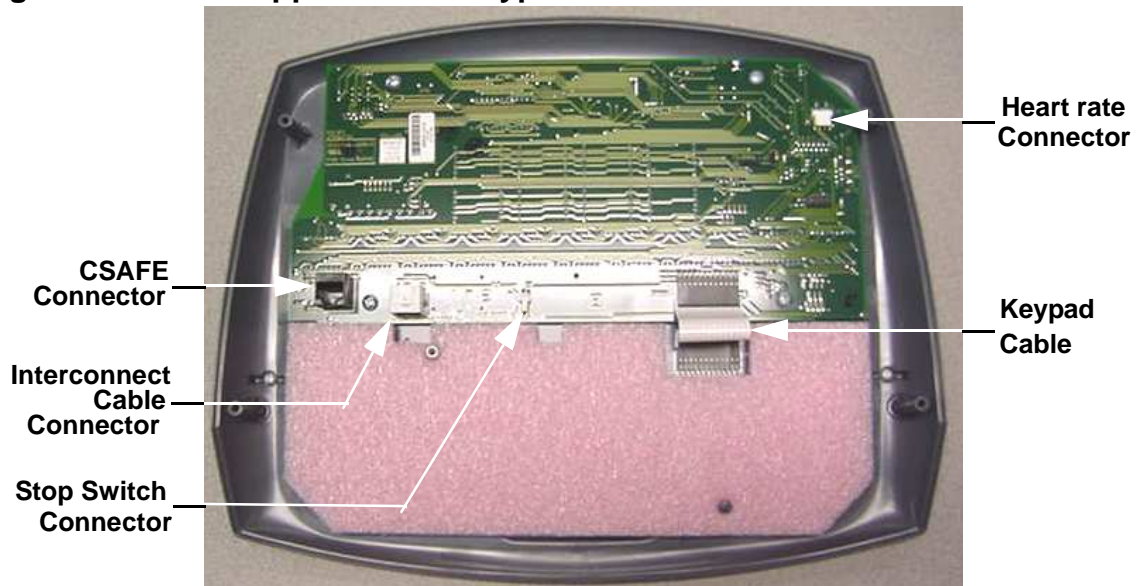

8. Holding the display housing by the plastic portions, do not handle the upper PCA or keypad PCA, reconnect the interconnect cable to the upper PCA.
9. Set the circuit breaker in the “on” position.
10. If a “key depressed” message is immediately displayed when the treadmill is powered up, replace the upper PCA.
11. If a “key depressed” message is not displayed when the treadmill is powered up, replace the display housing front panel. The display housing front panel is equipped with the keypad.
12. If you have performed all of the procedures above and have been unable to correct the problem, call Precor customer service.
13. Access the diagnostics program per procedure 2.1. If the key(s) necessary to access the diagnostic program is not functioning, skip to step 14.
14. Test the keypad per Procedure 2.1, step 6.
15. If all of the keys test good, the problem may be user error or a key function that is normally disabled during a particular user program.

16. If one or more keys do not function correctly, either the keypad (display housing) or upper PCA could be defective. Replace the display and repeat step 14. If the display housing did not correct the problem, re-install the original display housing and replace the upper PCA.
17. If you have performed all of the procedures above and have been unable to correct the problem, call Precor customer service.

Procedure 5.2 - Troubleshooting the Lift System

Lift System Description:

The lift system on these units consists of an AC line voltage driven lift motor (120 Vac), and an internal 1 K Ω potentiometer for lift position identification. The lift motor contains two motor windings, one to operate the motor in an “upward” direction and the other to operate the motor in a “downward” direction. As the lift motor is operated, the motor also rotates the potentiometer via an internal gear system. Therefore, the position of the lift system can be determined by monitoring the value of the internal potentiometer. The lift motor is initially set at a known starting position (calibration, See Procedure 4.1), subsequent motor movement is tracked via the potentiometer resistance reading.

Note:

All resistance measurements must be performed with power removed from the treadmill. Performing resistance measurements with voltage applied may damage your ohmmeter.

Procedure

1. If the lift motor operates but creates a lift error (error 40 or 42) go to step 16. If the lift motor will not move continue with step 2.
2. Set the treadmill’s circuit breaker in the “off” position and remove the AC line cord from the AC outlet.
3. Remove the F2 (Lift AC) fuse from the lower PCA. Using an ohmmeter, check the resistance of the F2 fuse. See Diagram 5.2. The fuse should measure approximately 0.1 Ω or less. If the fuse is open or high resistance, replace the fuse.

Diagram 5.2 - Lower PCA

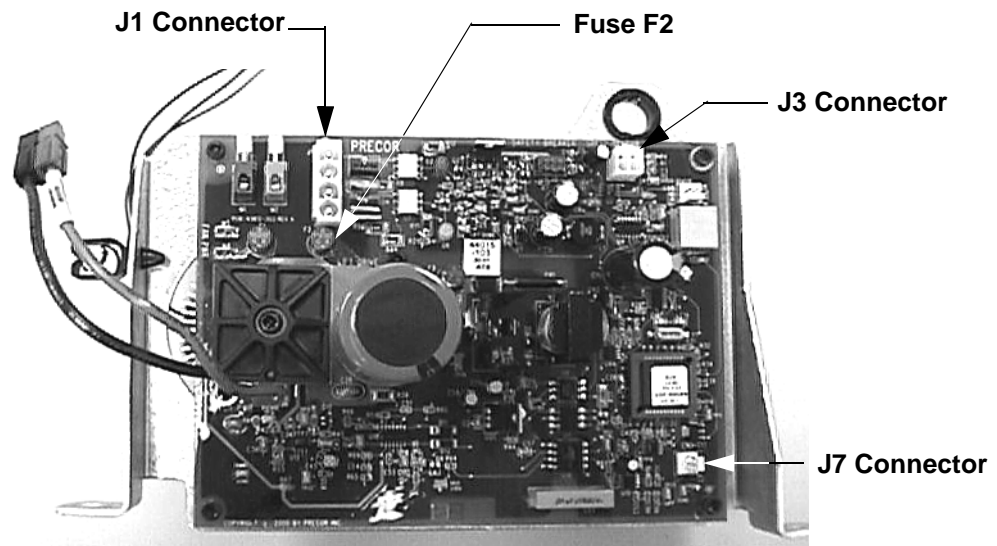

4. Insert the treadmill's line in the AC outlet and set the circuit breaker in the "on" position. Set the treadmill in the manual program and press the **LIFT ▲** key. If the lift motor operates normally, test treadmill operation per Section 3. If the lift motor still does not operate, retest the lift fuse per steps 2 & 3. If the fuse is open again, continue with step 13. If the fuse is good continue with step 5.
5. Connect an AC voltmeter between terminals 1 & 4 of the J1 connector. See Diagram 5.2. Set the treadmill in the manual program and press the **LIFT ▲** key. The AC voltmeter should read AC line voltage (120 Vac) and the red **UP** LED should illuminate. Note that the AC line voltage reading will only be present before an error condition is displayed.
6. If the F2 fuse is good and the **UP** LED illuminates and the AC voltmeter does not read the presence of AC line voltage replace the lower logic PCA per Procedure 6.3.
7. If the **UP** LED does not illuminate and the display indicates that the lift should be moving upward, replace the upper PCA per Procedure 6.8.
8. If the AC voltmeter reads the presence of AC line voltage and an error 40 is displayed, go to step 10.
9. If the AC voltmeter reads the presence of AC line voltage and an error 42 is displayed, continue with step 11.
10. Set the treadmill's circuit breaker in the "off" position and remove the AC line cord from the AC outlet. Remove the lift motor connector from the J1 connector on the lower PCA. Visually inspect the lift motor connector for broken or improperly crimped connections. Using an ohmmeter, read the resistance between terminals 1 & 4 and between terminals 3 & 4. Both readings should be approximately 12 Ω . If either reading is open or very high resistance, replace the lift motor per Procedure 6.1.
11. Set the treadmill's circuit breaker in the "off" position and remove the AC line cord from the AC outlet. Remove the lift motor connector from the J7 connector on the lower PCA. Visually inspect the lift motor connector for broken or improperly crimped connections. Using an ohmmeter, measure between terminals 1 & 3, 1 & 2 and 2 & 3 of the lift motor connector. Terminals 1 and 3 should read approximately 1 K Ω . The sum of the two readings between terminals 2 & 3 and 1 & 2 should total approximately 1 K Ω . If either reading is open or very high resistance, replace the lift motor per Procedure 6.1.
12. If you have performed all of the procedures above and have been unable to correct the problem, call Precor customer service.
13. Set the treadmill's circuit breaker in the "off" position and remove the AC line cord from the AC outlet. Remove the lift motor connector from the J1 connector on the lower PCA. Visually inspect the lift motor connector for broken, frayed or improperly crimped connections. Using an ohmmeter, read the resistance between terminals 1 & 4, 3 & 4 and 1 & 3. The readings should be approximately 12 Ω , 12 Ω and 24 Ω , respectively. If the reading is significantly low, replace the lift motor per Procedure 6.1.

14. If the resistance readings in step 13 are normal, replace the lower logic PCA per Procedure 6.3.
15. If you have performed all of the procedures above and have been unable to correct the problem, call Precor customer service.
16. Set the treadmill's circuit breaker in the "off" position and remove the AC line cord from the AC outlet. Remove the lift motor connector from the J7 connector on the lower logic PCA. Visually inspect the lift motor connector for broken or improperly crimped connections. Using an ohmmeter, measure between terminals 1 & 3, 1 & 2 and 2 & 3 of the lift motor connector. Terminals 1 and 3 should read approximately 1 K Ω . The sum of the two readings between terminals 2 & 3 and 1 & 2 should total approximately 1 K Ω . If either reading is open or very high resistance, replace the lift motor per Procedure 6.1.
17. If the resistance measurements in step 16 are normal, the problem may be either the lower logic PCA or the upper PCA. Replace the lower logic PCA. If the problem persists, reinstall the original lower logic PCA and replace the upper PCA.
18. If you have performed all of the procedures above and have been unable to correct the problem, call Precor customer service.

Procedure 5.3 - Troubleshooting the Speed Sensor

Note:

The speed sensor is a hall effect sensor that emits a pulse when a flywheel lobe passes between its transmitter and receiver. The speed control circuit processes the pulse train emitted by the speed sensor. The speed sensor signal is a real time representation of the operating speed of the treadmill. The speed control circuit compares the real time speed (speed sensor output) with the speed that it expects the treadmill to be operating at and acts accordingly to control treadmill speed or initiate an error code sequence, if necessary. Typically, if a problem exists with the speed sensor the drive motor will operate (perhaps only briefly) before a speed related error occurs (errors 20-26).

1. Set the treadmill circuit breaker in the "on" position. Using a DC voltmeter, measure the voltage between terminal 3 of J3 (green wire) and terminal 4 of J3 (black wire) on the lower PCA. Slowly, rotate the drive motor flywheel. The voltage should read approximately 0.25 Vdc when a flywheel lobe is between the speed sensor "legs" and approximately 5 Vdc when a flywheel lobe is not between the speed sensor "legs".

Diagram 5.3 - Speed Sensor Mounting

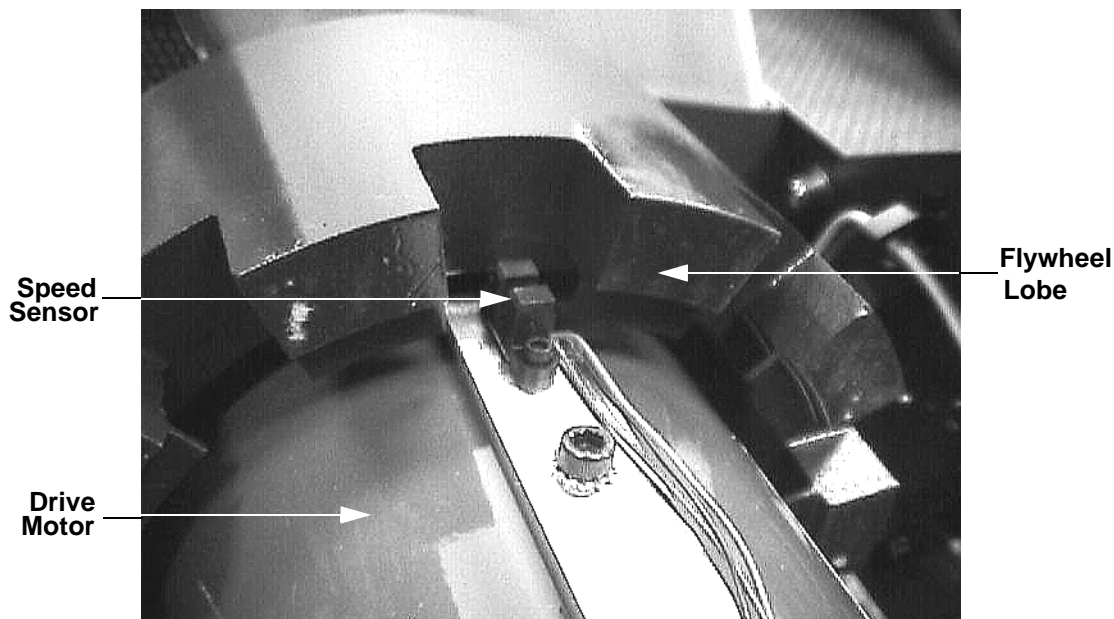

2. If the voltages in step 1 are correct, go to step 5. If the voltage in step 1 is 0 Vdc or significantly low when a flywheel lobe is between the speed sensor "legs", continue with step 3.

3. Measure the voltage between terminal 1 of J3. (red wire) and terminal 4 of J3 (black wire) on the lower PCA, see Diagram 5.2. The voltage should read approximately 5 Vdc. If the voltage is missing or significantly low, disconnect the speed sensor plug from the lower PCA. Measure the voltage between pins 1 & 4 of the J3 connector on the lower PCA. If the voltage is approximately 5 Vdc, replace the speed sensor. If the voltage is missing or significantly low, replace the lower logic PCA.
4. If at this point the speed sensor output is good, but a speed error occurs, replace the upper PCA.
5. If you have performed all of the above procedures and have been unable to correct the problem, call Precor Customer Support.

Procedure 5.4 - Troubleshooting the External A.C. Power Source

It is extremely important that any Precor treadmill be connected to and operated on a dedicated 20 amp A.C. circuit. A 20 amp dedicated circuit is defined as: a circuit fed by a 20 amp circuit breaker that feeds a single load. A treadmill operating from a non-dedicated circuit or a circuit breaker of less than 20 amps capacity will not have the necessary power available to operate normally under higher load conditions. The lack of available power can cause any number of symptoms ranging from numerous intermittent (seemingly inexplicable) error conditions, poor speed control, or tripping the house circuit breaker.

If any of the above symptoms exist the external A.C. circuit must be checked and confirmed to be a 20 amp dedicated circuit **before** troubleshooting the treadmill.

In addition the A.C. voltage must be checked. Nominal A.C. operating voltage on 120 Vac circuits is 105 Vac to 120 Vac. Nominal A.C. operating voltage on 240 Vac circuits is 208 Vac to 240 Vac. For operator safety considerations and to minimize electrostatic discharge conditions the A.C. frame ground continuity must also be verified to be a low resistance connection to the A.C. distribution ground bar.

Important

If the A.C. circuit feeding a treadmill is found to be a non-dedicated circuit or a circuit equipped with a circuit breaker with a capacity of less than 20 amps, the A.C. circuit must be corrected to be a 20 amp dedicated circuit **before** any reliable troubleshooting can be performed on the treadmill. More importantly, a non-dedicated circuit may constitute a safety hazard to the treadmill operator.

120 Vac Systems

120 Vac distribution systems utilize a single pole circuit breaker (hot lead) and a neutral lead connected to a common neutral (ground) bar. The A.C. safety ground (green wire) is connected to a separate ground bar in the distribution system.

The most common problems found are (1) the circuit is fed by a circuit breaker of less than 20 amp capacity, (2) the circuit breaker correctly feeds a single A.C. outlet but the neutral is common between several A.C. outlets and (3) both the hot and neutral leads feed several A.C. outlets. The appropriate correction action or actions (see below) must be followed if any of the above conditions exist. **Corrective actions should only be undertaken by a licensed electrician.**

1. The circuit breaker feeding the treadmill is not a 20 amp circuit breaker.

If the circuit breaker is greater than 20 amps, the circuit breaker should be replaced with a 20 amp circuit breaker. If the circuit breaker is less than 20 amps the circuit breaker must be replaced with a 20 amp circuit breaker and the wiring from the A.C. distribution must be capable of safely handling 20 amps. If the A.C. wiring is under sized, it must be replaced with wire capable of safely handling 20 amps. Please, refer to local electrical codes when determining the appropriate wire size for a 20 amp circuit.

2. The circuit breaker correctly feeds a single A.C. outlet but the neutral is common between several A.C. outlets.

The common neutral lead must be removed from treadmill's A.C. outlet and a new neutral lead from the treadmill's A.C. outlet to the A.C. neutral distribution bar must be added.

3. Both the hot and neutral leads feed several A.C. outlets.

Both the common neutral and hot leads must be removed from treadmill's A.C. outlet and a new neutral lead and hot lead from the treadmill's A.C. outlet to the A.C. neutral distribution bar and circuit breaker must be added.

240 Vac Systems

240 Vac distribution systems utilize a double pole circuit breaker (two hot leads) The A.C. safety ground (green wire) is connected to a ground bar in the distribution system.

The most common problems found are (1) the circuit is fed by a circuit breaker of less than 20 amp capacity and (2) both the hot leads feed several A.C. outlets. The appropriate correction action or actions (see below) must be followed if any of the above conditions exist. **Corrective actions should only be undertaken by a licensed electrician.**

1. The circuit breaker feeding the treadmill is not a 20 amp circuit breaker.

If the circuit breaker is greater than 20 amps, the circuit breaker should be replaced with a 20 amp circuit breaker. If the circuit breaker is less than 20 amps the circuit breaker must be replaced with a 20 amp circuit breaker and the wiring from the A.C. distribution must be capable of safely handling 20 amps. If the A.C. wiring is under sized, it must be replaced with wire capable of safely handling 20 amps. Please, refer to local electrical codes when determining the appropriate wire size for a 20 amp circuit.

2. Both the hot leads feed several A.C. outlets.

Both hot leads must be removed from treadmill's A.C. outlet and two new hot leads from the treadmill's A.C. outlet to the circuit breaker must be added.

A licensed electrician may use the followings hints to determine if an A.C. service is dedicated.

1. If, on a 120 Vac system, the A.C. distribution panel contains more circuit breakers than neutral leads, the system has shared neutral leads and is not dedicated.
2. If an A.C. outlet (120 or 240 Vac) has multiple hot and/or neutral leads, it is not a dedicated.
3. If either of the above conditions exist, the system is not dedicated. However, absence of the above conditions does not necessarily mean that the system is dedicated. If any doubt exists about A.C. systems dedication, point to point tracing of the A.C. wiring may be the only way to prove system dedication.

Procedure 5.5 - Troubleshooting Heart Rate

Circuit Description

The hand held heart rate system is actually a dual system, that is, it can accept a heart rate signal from either the hand held heart rate contacts on the unit's handlebar or from a Polar heart rate chest strap transmitter. The PCA is configured for hand held priority. That is, if both a chest strap and hand heart rate signal are being received, the system will accept the hand held signal and ignore the chest strap signal. If a hand held signal is not being received, the system will accept the chest strap signal.

Note:

There are four typical failure modes for the hand held/chest strap heart rate system. They are: hand held is normal - no chest strap reading; no hand held reading - chest strap normal; no hand held or chest strap reading or constant or intermittent readings when neither hand held or chest strap are in use.

Diagram 5.4 - Hand held/chest strap heart rate PCA

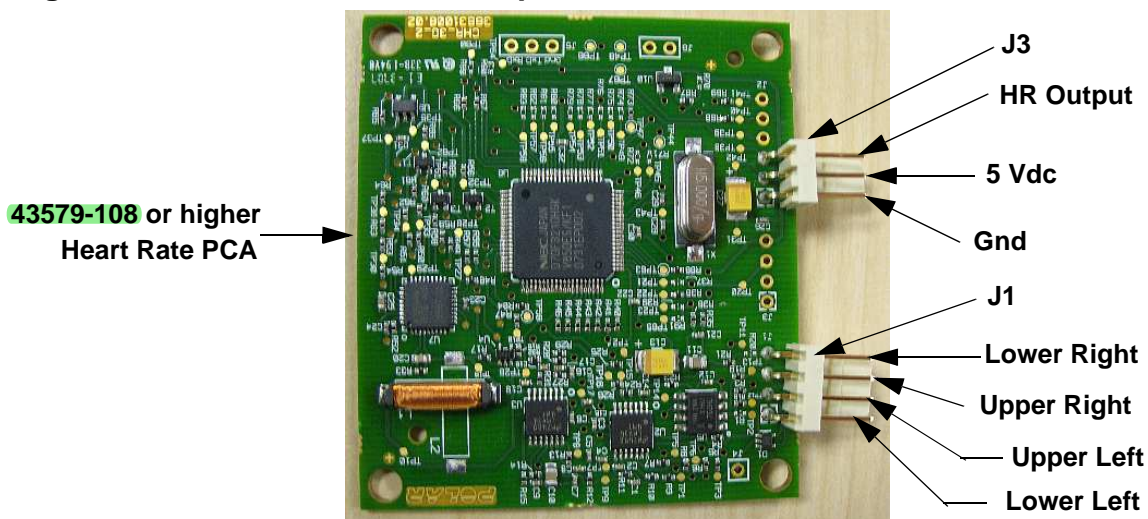

Normal hand held reading - No chest strap reading

1. Access the diagnostic program (Procedure 3.2). Advance to the heart rate display portion of the diagnostic program. Verify that a chest strap signal is not being accepted with either a Polar heart rate test transmitter or a known good chest strap transmitter. If this reading is good, skip to step 3.
2. Using a known good Polar heart rate chest strap, verify that the heart rate operates with the known good chest strap. If the known good Polar chest strap does corrects the problem, replace the original chest strap transmitter.
3. If the above procedures did not correct the problem, replace the heart rate PCA.

No hand held reading - Normal chest strap reading

4. Access the diagnostic program (Procedure 3.2). Advance to the heart rate display portion of the diagnostic program. Verify that a hand held signal is not being accepted by firmly grasping both the right and left hand held contacts on the handlebars. Cover as much of the contact surface area with your hands as possible (without moving your hands), you should receive a heart rate reading within ten seconds.
5. If the hand held signal is now being accepted, something in the near vicinity is radiating RF (radio frequency) energy that is being received by the chest strap portion of the heart rate PCA.
6. If a hand held signal still not being accepted, skip to step 8.
7. Replace the heart rate PCA with a **43579-108** (or higher) heart rate PCA. **43579-108** and higher versions of heart rate PCA are less susceptible to radiated RF energy.
8. Access the diagnostic program (Procedure 3.2). Advance to the heart rate display portion of the diagnostic program. Verify that a hand held signal is not being accepted by firmly grasping both the right and left hand held contacts with the opposite hands, right hand on the left handlebar contacts and left hand on the right handlebar contacts. Cover as much of the contact surface area with your hands as possible, you should receive a heart rate reading within ten seconds. If a hand held signal is still not being accepted, skip to step 10.
9. If a hand held signal was accepted in step 11, the hand held contact wiring is reversed. The end of the wire harness that connects to the hand held contacts in the handlebar is segregated into two groups. One group has blue shrink wrap around it and the other group has black shrink wrap around it. The "blue" group must go to the right hand contacts and the "black" group must go to the left hand contacts. In both groups the black wire must go to the lower contact and the red wire must go to the upper contact. If necessary, rewire the hand held contacts as described above and test as described in step 4.
10. If the wiring is correct, refer to Diagram 6.3 for the following measurements. With an ohmmeter measure between the "lower right contact" pin on the J1 connector and the lower right hand held heart rate contact on the handlebar. The reading should be 1 Ω or less. Measure between the "upper right contact" pin on the J1 connector and the upper right hand held heart rate contact on the handlebar. The reading should be 1 Ω or less. Measure between the "upper left contact" pin on the J1 connector and the upper left hand held heart rate contact on the handlebar. The reading should be 1 Ω or less. Measure between the "lower left contact" pin on the J1 connector and the lower left hand held heart rate contact on the handlebar. The reading should be 1 Ω or less. If any of the above readings are greater than 1 Ω , replace the heart rate PCA to handlebar wire harness.

No hand held reading - No chest strap reading

11. Access the diagnostic program (Procedure 3.2). Advance to the heart rate display portion of the diagnostic program. Verify that neither a chest strap signal or a hand held signal is being accepted with either a heart rate test transmitter or a chest strap transmitter.
12. Check the plug/connector connections on both the heart rate PCA (J4), and upper PCA (J1).
13. If neither a chest strap signal or a hand held signal is being accepted, measure between the "ground" and "5 Vdc" pins on J4 for 5 Vdc. If 5 Vdc is present, replace the heart rate PCA.
14. If 5 Vdc is not present, remove the connector from J4 of the heart rate PCA. Measure between the "ground" and "5 Vdc" pins of the connector (just removed from the heart rate PCA) for 5 Vdc. If 5 Vdc is present, replace the heart rate PCA. If the 5 Vdc is not present, measure between the corresponding pins of J1 on the upper PCA (red and black wires). If 5 Vdc is not present replace the upper PCA. If 5 Vdc is present, replace the upper PCA to heart rate PCA cable.

Constant or intermittent readings when neither the hand held or chest strap is in use

15. Verify that a ferrite core is clamped around the heart rate PCA to upper PCA cable.
16. Constant or intermittent heart rate readings when neither heart rate system is in use is caused by something in the near vicinity radiating RF energy that is being received by the chest strap portion of the heart rate PCA.
17. Replace the heart rate PCA with a **43579-108** (or higher) heart rate PCA. **43579-108** and higher versions of heart rate PCA are less susceptible to radiated RF energy

Procedure 5.6 - Running Belt & Deck Troubleshooting

This procedure is to be used to determine the condition of the running belt and running deck combination. A clamp-on ammeter will be used to measure the treadmill's A.C. input current under load. The A.C. input current is a direct indication of the load being placed on the treadmill. Treadmill loading consists of several factors, the user's weight, treadmill speed, treadmill incline setting and the condition of the running belt and running deck condition. By making all of the other factors consistent we will be able to determine the relative condition of the running belt and deck combination. The A.C. input current measurements will be performed at 3 m.p.h. (4.8 k.p.h.) and 0% incline. Because the loading varies with the user's weight, you should perform the A.C. input current measurement test on a new running belt and deck combination. That will provide you with a benchmark reading to account for your individual weight.

Because the A.C. input current reading will pulse between a high value (during foot plant) and a low reading (between foot plants) we suggest the use of an analog clamp-on ammeter. An analog ammeter makes it very easy to see the A.C. current pulses. The refresh rate on digital ammeters may make it difficult to see the current peaks.

1. Remove the treadmill's motor cover and place the A.C. clamp-on ammeter on the brown wire from the A.C. input module (or A.C. power cord) to the circuit breaker (on/off switch). See the illustration below.

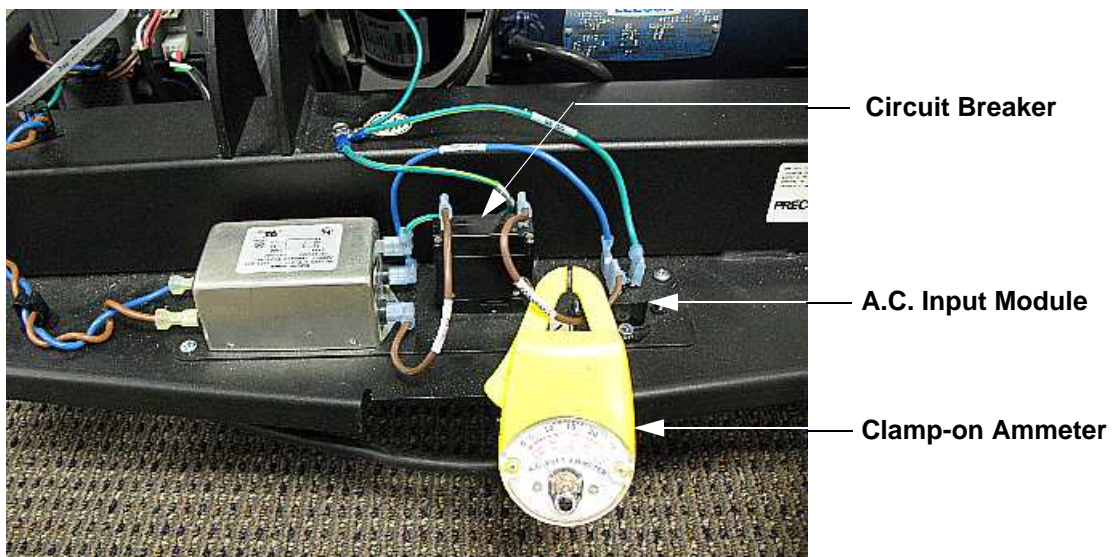

2. Set the treadmill's speed at 3 m.p.h. (4.8 k.p.h.) and the incline at 0%. Walk on the treadmill and observe the peak A.C. current reading. Typical peak A.C. current readings on a new running belt and deck are between 3 and 6 amperes.
3. If the peak current reading approach 20 amperes, the running belt should be replaced. The running deck should be flipped or replaced if the running deck has been previously flipped. See Procedure X for running belt and running deck replacement.

4. If the peak A.C. current readings are greater than on a new running belt and deck combination but not approaching 20 amperes, the reading will give you an indication of the running belt and deck combination's general condition.

Procedure 6.1 - Replacing the Lift Motor

Note:

The replacement lift motor must be calibrated prior to installation. The defective lift motor is then removed and the calibrated replacement lift motor is installed.

1. If the incline is at 0%, skip to step 3.
2. Set the treadmill circuit breaker in the “on” position. Press the **QUICK START** to start the running belt. Use the **INCLINE ▼** key to lower the incline to 0%
3. Set the treadmill circuit breaker in the “off” position and remove the AC line cord from the AC outlet.
4. Disconnect the lift motor plugs from J1 and J7 connectors of the lower logic PCA. See Diagram 5.2. Remove the lift motor’s green frame ground wire from the lift motor support bracket.
5. Lay the replacement lift motor on the floor in front of the treadmill and connect it’s two plugs to the J1 & J7 connectors of the lower logic PCA.
6. Calibrate the lift motor per Procedure 4.1, steps 4-7.
7. Lay the treadmill on either its left or right side as convenient.
8. Remove the hitch and clevis pins from the top and bottom of the lift motor. Remove the lift motor from the treadmill.
9. Set the calibrated lift motor in its mounting position. Replace the upper clevis and hitch pins.
10. Replace the lower clevis and hitch pins. It may be necessary to slightly rotate the lift tube to align it so that the clevis pin may be inserted. To align the hole in the lift tube rotate it in the direction that will cause the least amount of rotation to make alignment possible.
11. Route the lift motor cables to the lower PCA. Plug the lift motor plugs into the J1 & J7 connectors on the lower logic PCA.
12. Check treadmill operation per Procedure 3.

Procedure 6.2 - Replacing the Lift Platform

1. Set the treadmill circuit breaker in the “off” position. Remove the AC line cord from the AC outlet.
2. Remove the treadmill hood. Carefully, lay the treadmill on it's right side.
3. Remove the hitch pin and clevis pin that fastens the lift motor tube to the lift platform. While the lift tube is not fastened to the lift platform, care must be taken to not allow the lift tube to rotate. If the lift tube rotates, the lift motor must be re-calibrated per Procedure 4.1.
4. Using a punch or stout screwdriver press the lift platform mounting pins toward the treadmill frame and out of the lift platform. Remove the lift platform from the treadmill.

Diagram 6.1 - Lift Platform Mounting Pin

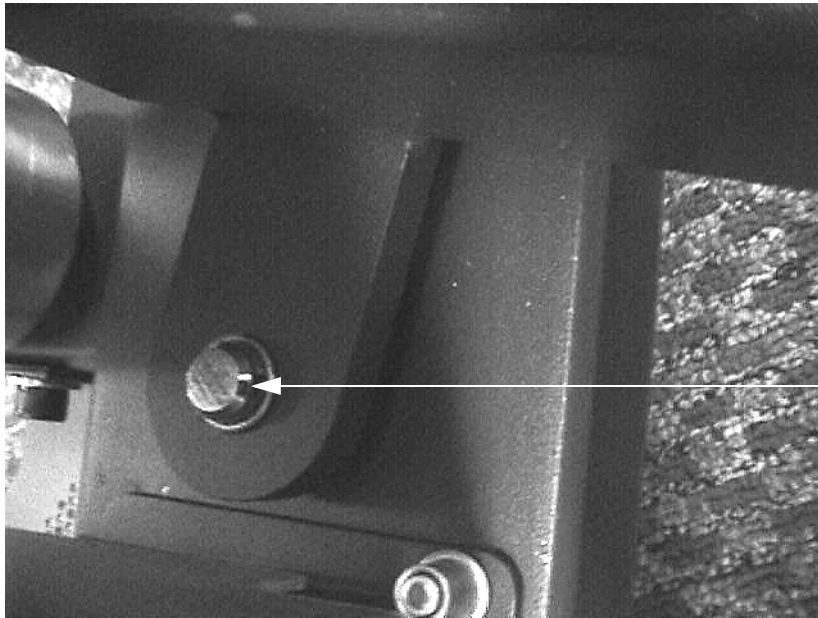

**Lift Platform
Mounting Pin**

5. With a screwdriver or similar tool carefully pry the forward end of the aluminum treadmill frame trim away from the treadmill frame, see Diagram 6.2.
6. Using a flat bladed tool, reach under the treadmill trim and press the lift platform mounting pin into the lift platform. Replace the hitch pin in the lift platform mounting pin. Press the treadmill frame trim back into place.
7. Hold the lift platform against the bottom of the treadmill and carefully roll the treadmill back into an upright position. Carefully lay the treadmill on its left side and repeat the procedure in step 6.

Diagram 6.2 - Treadmill Frame Trim

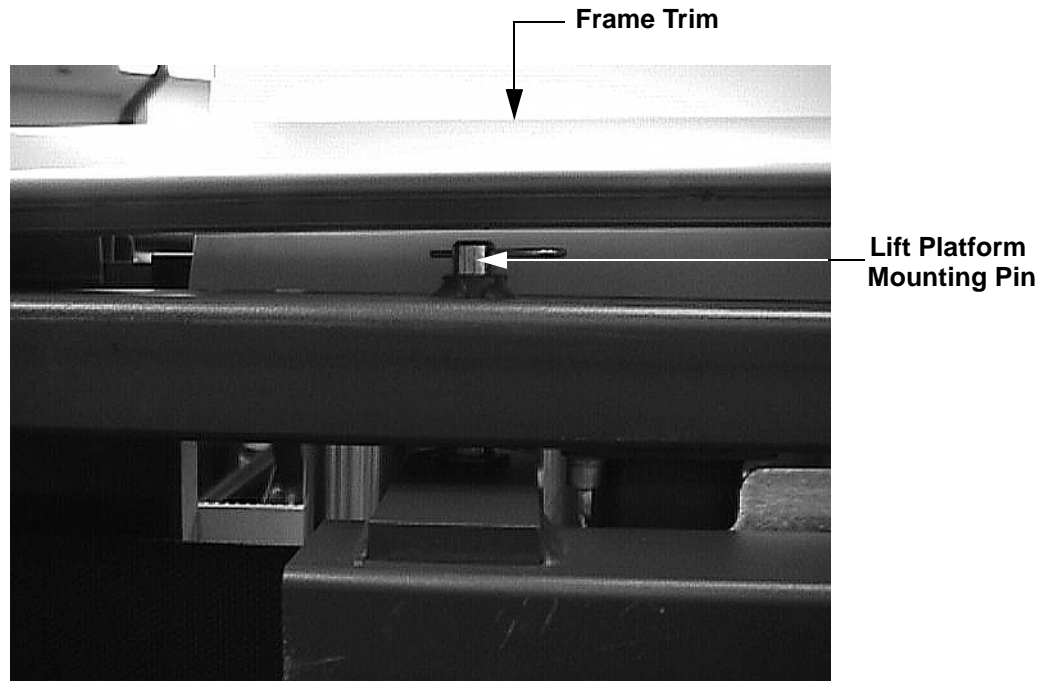

Front →

8. Check treadmill operation per Procedure 3.

Procedure 6.3 - Replacing the Lower PCA

1. Set the treadmill circuit breaker in the “off” position. Remove the AC line cord from the AC outlet.
2. Disconnect the lower PCA drive motor connector from the drive motor. Disconnect Both lift motor connectors, the speed sensor connector, the drive motor fan connectors, the lower PCA fan connector and the AC input wires from the lower PCA.
3. Remove both lower PCA mounting screws and remove the lower PCA. See Diagram 6.3.

Diagram 6.3 - Lower PCA

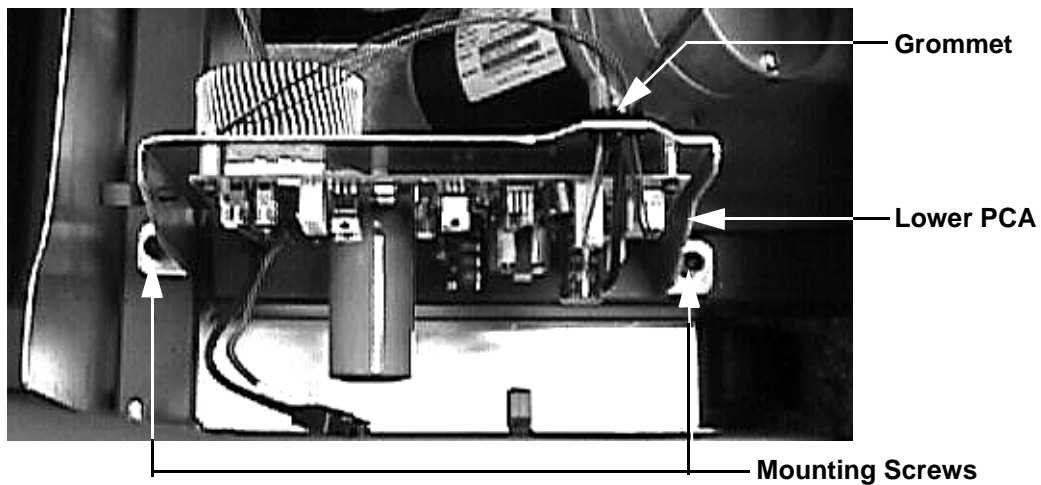

4. Set the replacement lower PCA in its mounting position and fasten it with the screws removed in step 3. Torque the lower PCA mounting screws to 120 inch pounds.
5. The AC input wires are the blue and brown wires AC line filter on the front dress panel. Connect the brown AC input wire to the M2 terminal and the blue AC input wire to the M1 terminal of the lower PCA.
6. Connect the brown drive motor fan wire to terminal M4 and the blue drive motor fan wire to the M5 terminal on the lower PCA.
7. Connect the black and red drive motor wires to the mating black and red connectors on the lower PCA.
8. Feed the speed sensor connector through the grommet in the lower PCA bracket and insert it in the J3 connector of the lower PCA.
9. Feed the lower PCA fan r connector through the grommet in the lower PCA bracket and insert it in the J4 connector of the lower PCA.

10. Feed the three pin lift motor connector through the grommet in the lower PCA bracket and insert it in the J7 connector of the lower PCA.
11. Insert the large lift motor connector in the J1 connector of the lower PCA.
12. Dress all of the above wiring into the appropriate wire clips along their routing.
13. Insert the AC line cord from the AC outlet. Set the treadmill circuit breaker in the "on" position.
14. Check treadmill operation per Procedure 3.

Procedure 6.4 - Replacing the Speed Sensor

1. Set the treadmill circuit breaker in the “off” position. Remove the AC line cord from the AC outlet.
2. Disconnect the plug from the J3 connector on the lower PCA.
3. Rotate the flywheel so that the speed sensor is between flywheel lobes.
4. Remove the screws that fastens the speed sensor mounting bracket to the treadmill drive motor. See Diagram 6.4.

Diagram 6.4 - Speed Sensor Mounting

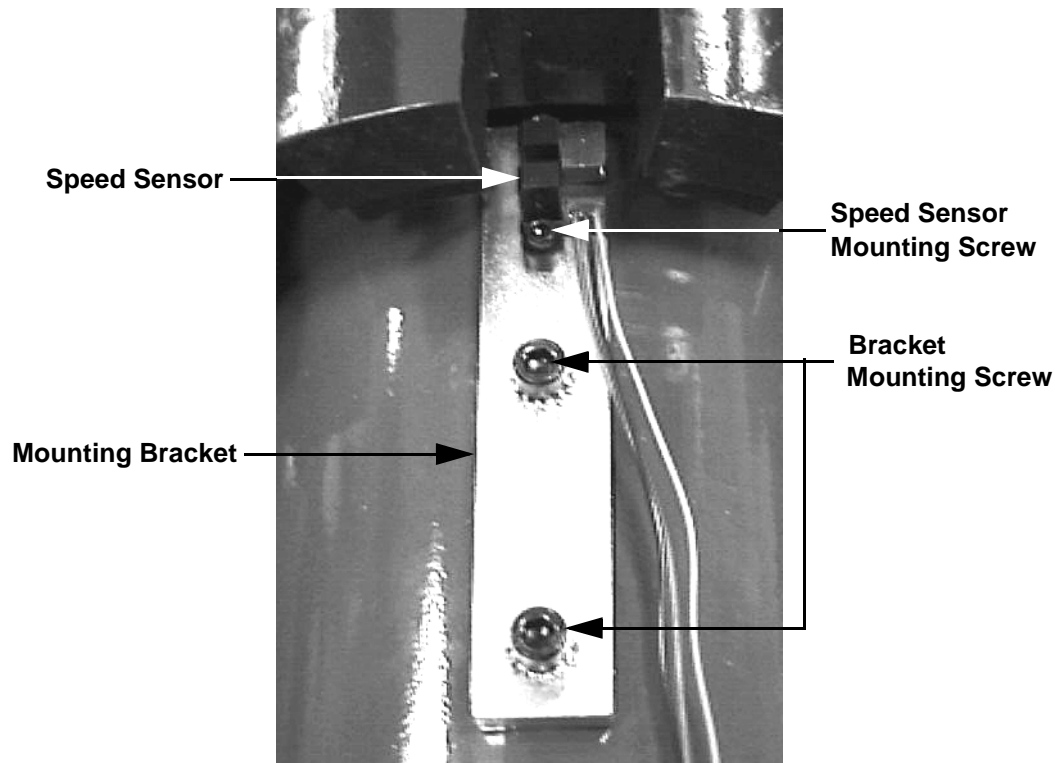

5. Remove the mounting bracket from the drive motor.
6. Remove the two screws that fasten the speed sensor to the bracket.
7. Mount the replacement speed sensor on the mounting bracket with the screws removed in step 6. Torque the screws to 8 inch pounds.
8. Mount the bracket on the drive motor with the screws removed in step 4. Torque the mounting screws to 25 inch pounds.

9. Feed the speed sensor connector through the grommet in the lower PCA bracket and insert it in the J3 connector of the lower PCA.
10. Slowly rotate the flywheel to ensure that the flywheel lobes do not contact the speed sensor.
11. Set the treadmill circuit breaker in the “on” position and check treadmill operation per Procedure 3.

Procedure 6.5 - Replacing Drive Motor

1. Set the treadmill circuit breaker in the "off" position and unplug the treadmill's line cord from the AC outlet.
1. Remove the hood.
2. The drive motor and flywheel are balanced as a matched pair. Since the flywheel is balanced to a specific motor, flywheels should not be removed from one and installed on a different motor. If the drive motor is replaced, the drive motor and flywheel should be replaced as a unit.
3. Remove the screws that fastens the speed sensor mounting bracket to the treadmill drive motor. See Diagram 6.4. Move the speed sensor and bracket as far from the drive motor as possible.
4. Remove the blue and brown wires from the drive motor cooling fan (9.35 only).
5. Disconnect the red and black drive motor wires from the lower PCA.
6. Loosen the four drive motor mounting bolts. See Diagram 4.3. Remove the drive belt from the drive motor pulley.
7. Remove the four bolts that fasten the drive motor to its mounting base. Remove the drive motor from the treadmill.
8. Remove the four screws that fasten the drive motor cooling fan onto the drive motor. Remove the fan from the drive motor (9.35 only).
9. Mount the drive motor cooling fan onto the replacement drive motor with the screws removed in step 7. Torque the fan mounting screws to 25 inch pounds.
10. Set the drive motor in it's mounting position. Replace and hand tighten the drive motor mounting screws removed in step 6. Set the drive belt in place on the drive motor pulley.
11. Tension the drive belt and mount the drive motor per Procedure 4.2, steps 3-5.
12. Connect the brown and blue fan wires to the drive motor cooling fan. The blue and brown wires can be connected to either terminal (9.35 only).
13. Connect the black and red drive motor wires to the mating black and red connectors on the lower PCA.
14. Set the speed sensor and mounting bracket in position on the drive motor and fasten with the screws removed in step 3. Torque the mounting screws to 25 inch pounds.
15. Re-install the hood.per Procedure 6.11

16. Check treadmill operation per Procedure 3.

Procedure 6.6- Replacing the Circuit Breaker

1. Set the treadmill circuit breaker in the “off” position and unplug the treadmill’s line cord from the AC outlet.
2. Remove the sheet metal screw that is approximately in the center of the treadmill dress panel. Remove the four bolts that fasten the treadmill dress panel to the treadmill.

Diagram 6.5 - Treadmill Dress Panel (Rear View)

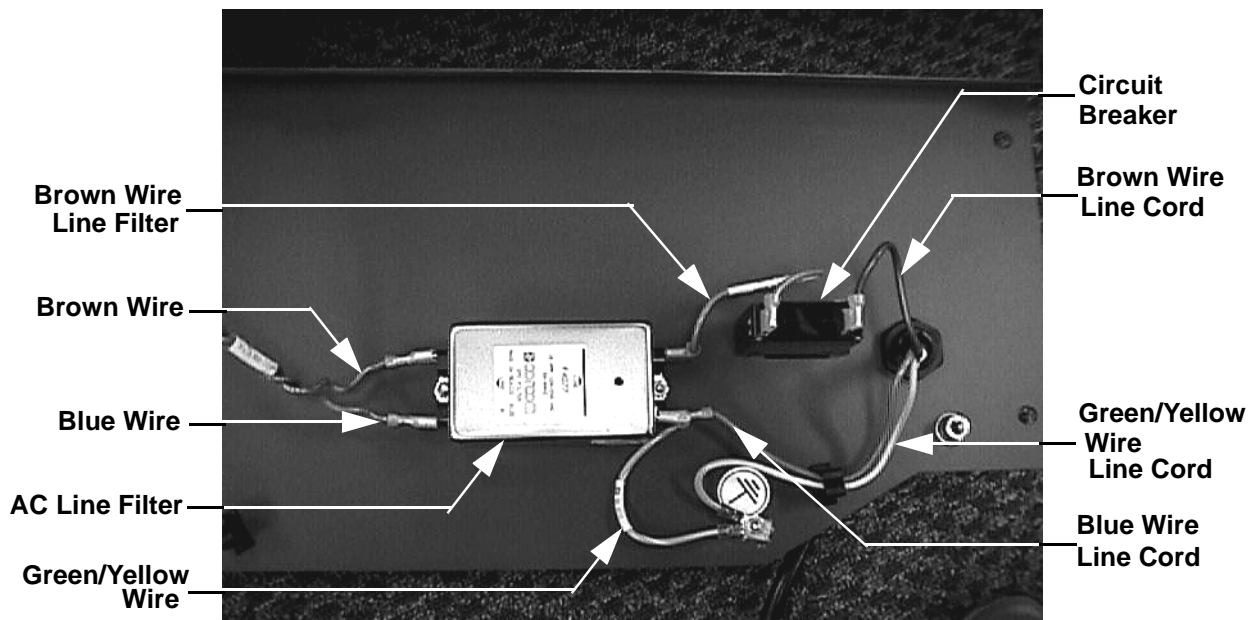

3. Disconnect both brown wires from the circuit breaker.
4. Note the orientation of the circuit breaker in the dress panel. The replacement circuit breaker must be mounted in the same orientation. Remove the circuit breaker mounting screws. Remove the circuit breaker from the treadmill.
5. Set the replacement circuit breaker in its mounting position. When viewed from the front the circuit breaker labeling should be with “OFF” on the right hand side. Fasten the circuit breaker to the treadmill dress panel using the screws removed in step 4.
6. Connect the brown wires from the line cord and AC line filter as shown in Diagram 6.5.
7. Set the dress panel in its mounting position, hand start the four mounting bolts and the sheet metal screw removed in step 2. Torque the four dress panel bolts to 120 inch pounds. Torque the sheet metal screw to 90 inch pounds.
8. Replace the hood per Procedure 6.11.

9. Check treadmill operation per Section 3.

Procedure 6.7 - Replacing the Line Filter

1. Set the treadmill circuit breaker in the “off” position and unplug the treadmill’s line cord from the AC outlet.
2. Remove the sheet metal screw that is approximately in the center of the treadmill dress panel. Remove the four bolts that fasten the treadmill dress panel to the treadmill.
3. Disconnect all of the wiring from the line filter.
4. Remove the mounting hardware that fastens the line filter to the treadmill dress panel.
5. Set the replacement line filter in it’s mounting position, the side with three terminals must face the circuit breaker. Fasten the line filter to the treadmill dress panel with the mounting hardware removed in step 4.
6. Connect the wiring to the line filter per Diagram 6.10.
7. Replace the AC line filter wiring as shown in Diagram 6.5.
8. Set the dress panel in its mounting position, hand start the four mounting bolts and the sheet metal screw removed in step 2. Torque the four dress panel bolts to 120 inch pounds. Torque the sheet metal screw to 90 inch pounds.
9. Replace the hood per Procedure 6.11.
10. Check treadmill operation per Section 3.

Procedure 6.8 - Replacing the Line Cord

1. Set the treadmill circuit breaker in the “off” position and unplug the treadmill’s line cord from the AC outlet.
2. Remove the sheet metal screw that is approximately in the center of the treadmill dress panel. Remove the four bolts that fasten the treadmill dress panel to the treadmill.
3. Remove the nut that fastens the line cord’s ground wire (green/yellow wire) to the dress panel.
4. Disconnect the line cord’s brown wire from the circuit breaker. Disconnect the line cord’s blue wire from the line filter.
5. Remove the line cord’s strain relief mounting nut and remove the line cord.
6. Remove the mounting nut from the replacement line cord and feed the replacement line cord through the treadmill dress panel. Fasten the line cord to the circuit breaker mounting plate with the nut removed in the previous step.
7. Connect the line cord’s brown wire to the circuit breaker per Diagram 6.5.
8. Connect the line cord’s blue wire to the line filter per Diagram 6.5.
9. Connect the line cord’s ground wire (green/yellow wire) to the treadmill dress panel with the hardware removed in step 3.
10. Set the dress panel in its mounting position, hand start the four mounting bolts and the sheet metal screw removed in step 2. Torque the four dress panel bolts to 120 inch pounds. Torque the sheet metal screw to 90 inch pounds.
11. Replace the hood per Procedure 6.11.
12. Check treadmill operation per Section 3.

Procedure 6.09 - Replacing the Drive Motor Brushes

1. Set the treadmill circuit breaker in the "off" position and unplug the treadmill's line cord from the AC outlet.
1. Remove the hood.
2. Remove the screws that retain the drive motor brush cover. Carefully, remove the heavy paper cover from the brush access opening.
3. Disconnect the brush wire from the tab on the brush housing. Remove the brush spring by depressing the tab on the brush spring.
4. Remove the brush from it's brush holder. See Diagram 6.6.

Diagram 6.6 - Drive Motor Brush

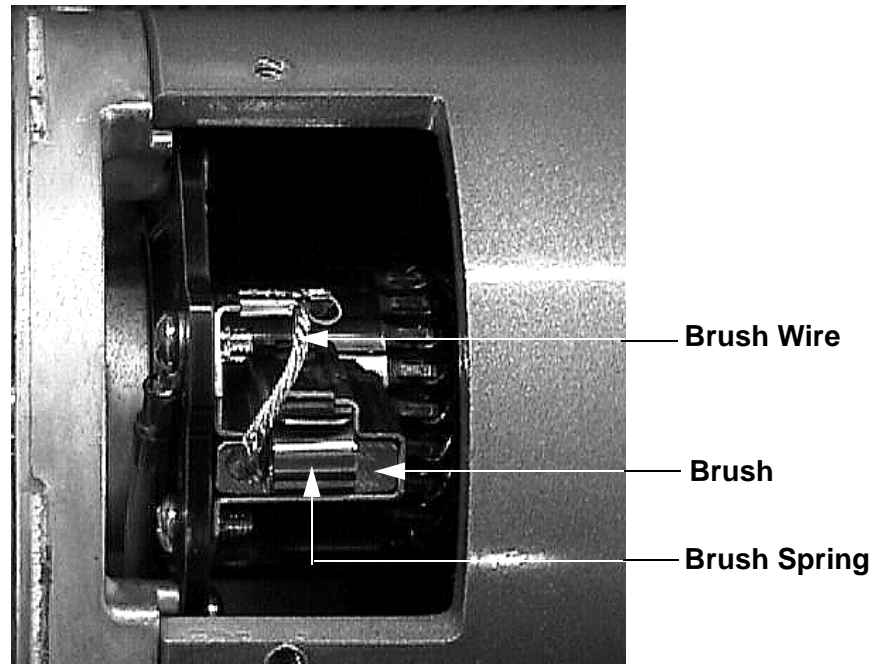

5. Slide the replacement brush into the brush holder. Be sure that the angled edge of the brush is oriented so that the brush face makes full contact with the motor commutator.
6. Reinstall the brush spring and connect the brush wire to the tab on the brush holder.
7. Replace the heavy paper cover in the brush access opening. Replace the brush cover and fasten it with the screws removed in step 3.
8. Repeat 3-8 with remaining drive motor brush.

9. Replace the hood per Procedure 6.11.
10. Check treadmill operation per Procedure 3.

Procedure 6.10 - Removing and Replacing the Hood

1. Set the treadmill circuit breaker in the “off” position and unplug the treadmill’s line cord from the AC outlet.
2. Remove the four bolts that mount the hood the treadmill. Note that only two front bolts utilize flat washers
3. Remove the hood from the treadmill.
4. The rear hood mounting nuts are mounted in slots and are able to “float”

Diagram 6.7 - Rear Hood Mounts

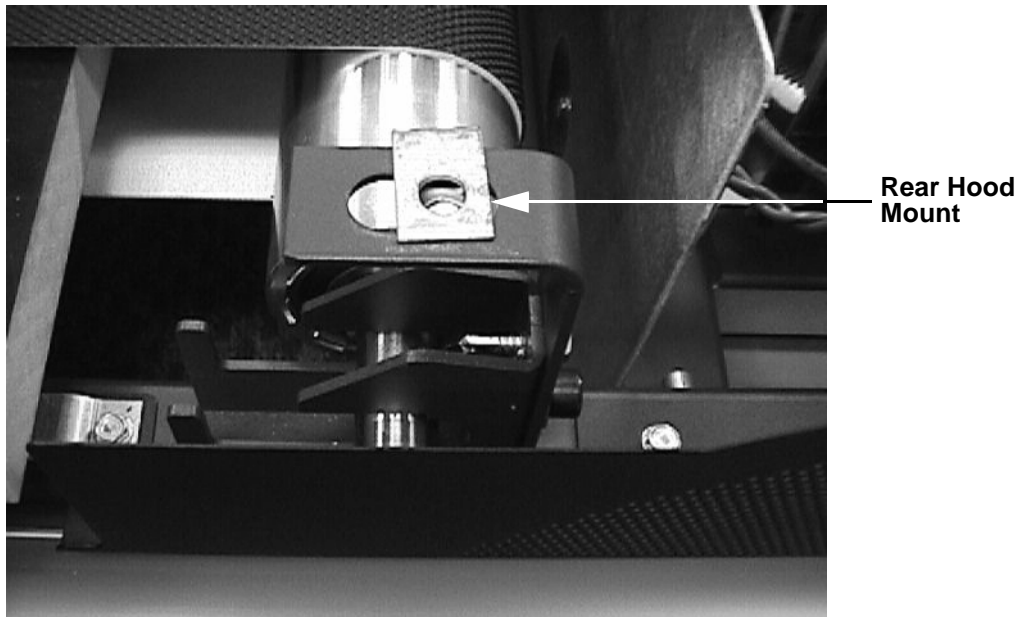

5. Set the replacement hood in its mounting position. Using a thin bladed screwdriver or similar tool into one of the rear hood mounting holes and use the screw driver to align the hood mounting nut with the hole in the hood. Hand start one of the rear hood mounting bolts.
6. Repeat step 5 for remaining rear hood mount.
7. Hand start the two front hood mounting bolts. Torque all four hood mounting bolts to 120 inch pounds.

Procedure 6.11 - Replacing the PROM

Anti-static kits (part number 20024-101) can be ordered from Precor.

1. The PROM and the associated printed circuit assembly (PCA) are static sensitive. Anti-static devices must be used and all anti-static precautions must be followed during this procedure.
2. Remove the printed circuit assembly per its associated procedure.
3. Currently we are using two styles of IC software packages. they are a 28 pin dual in line package (DIP28) and a forty-four pin square package (PLCC44). Each of these packages should be removed with a proper IC removal tool (see the illustrations below)



4. The IC's may inserted into their socket by hand by carefully aligning the notch on the IC with the notch on the IC socket and carefully pressing the IC into its socket. See the illustrations below for the alignment notches. Care must be taken that the IC legs on a DIP28 are all aligned in the socket to prevent the legs from bending when inserted. The PLCC44 IC must be carefully aligned squarely in its socket or it will not insert. Do not force the IC into its, socket. If it does not insert easily, remove the it and re-align it in its socket.

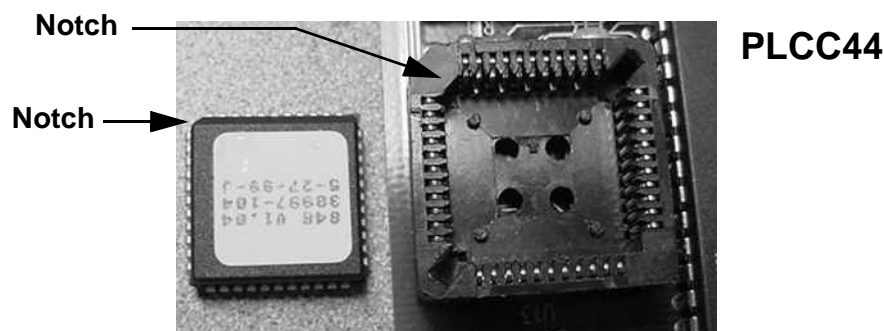
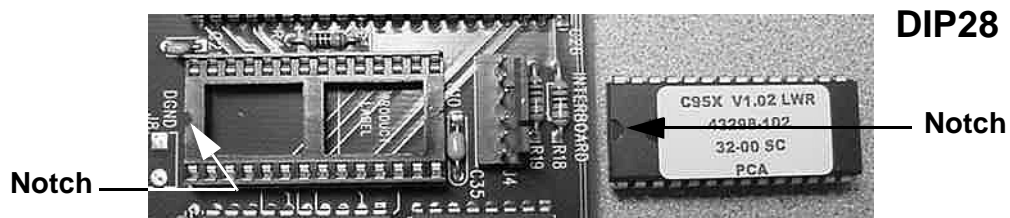

Procedure 6.12 - Drive Roller Replacement

This procedure is to be used to replace a drive roller while maintaining the drive belt's original tensioning and the running belt's original tension and tracking settings. Two running belt gauges, Precor part number 20007-101, are required. It is important that this procedure be followed to maintain correct drive belt and running belt tension. When tension is removed from the running belt, the belt requires 24 hours for it to "relax". If tension is removed from the belt and then re-tensioned without following this procedure or allowing a 24 hour relaxation period, the running belt may be over tensioned. Over tensioning the belt will lead to premature running belt wear, premature driver roller bearing failure and premature take up roller bearing failure.

1. Place two running belt gauges on each side of the running belt, being sure that the gauges are not across a belt seam. Set the gauges to the 3% mark as shown in the Illustration below.



2. Once set the belt gauges can not be disturbed or moved, doing so will invalidate the tension settings and necessitate a 24 hour relaxation period before the running belt can be re-tensioned.
3. Remove the end caps from the rear of treadmill to expose the take up roller mounting bolts. Remove the treadmill's motor cover.
4. Loosen, but do not remove the take up roller mounting bolts. The bolts are being loosened to remove tension from the running belt.

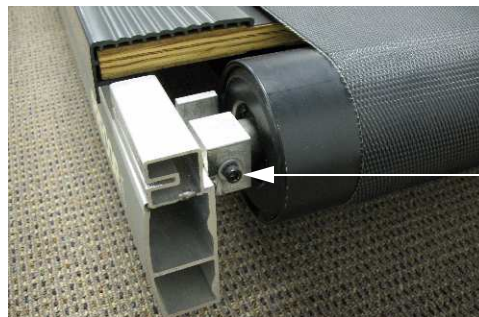

**Take Up Roller
Mounting Bolt**

5. Slowly rotate the drive motor flywheel while pressing the drive belt off of the drive roller pulley. Continue until the drive belt “walks” completely off of the drive roller pulley.

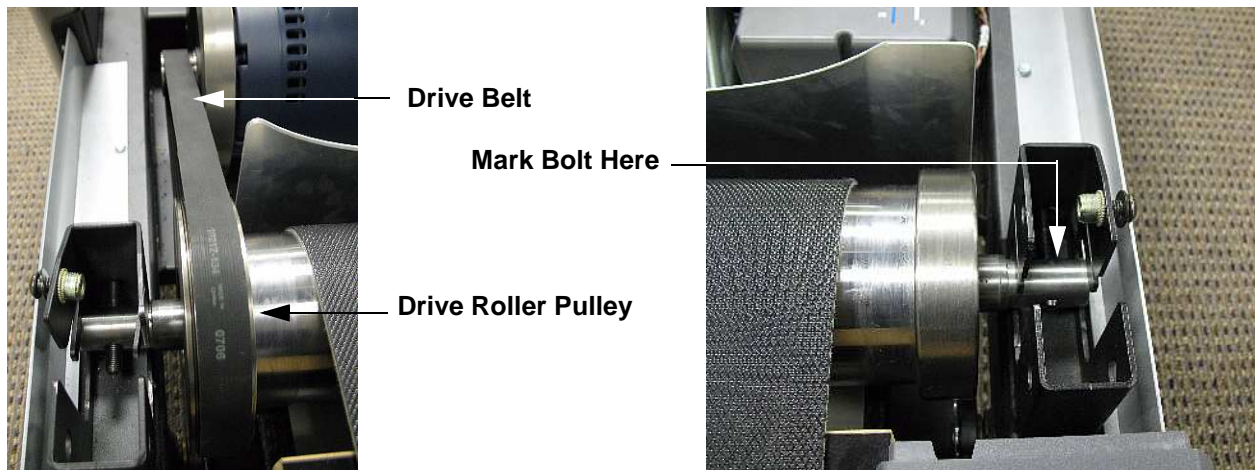

6. Using a fine tip marker or scribe, place a mark on the right hand drive roller mounting bolt directly in front of the drive roller shaft. The bolt is being marked so that the drive roller can be returned to the exact same position. The use of a fine marking line allows for more accuracy when the replacement drive roller is installed.
7. Remove both drive roller mounting bolts. Remove the drive roller from the treadmill.
8. Slide the replacement drive roller into running belt and into the drive belt. Hand start both drive roller mounting bolts.
9. Tighten the left hand drive roller bolt fully. The left hand side of the drive roller should be as far forward as possible.
10. Tighten the right hand drive roller bolt until the mark placed on it in step 6 aligns with the front edge of the drive roller shaft. Steps 8 and 9 should place the drive roller into its original position and should now be square to the treadmill frame.
11. Slowly rotate the drive motor flywheel while pressing the drive belt onto of the drive roller pulley. Continue until the drive belt “walks” completely onto the drive roller pulley. Be sure that the drive belt is fully onto and correctly aligned on the drive roller pulley.
12. Alternate tightening the two take up roller mounting bolts, in order to tighten both ends evenly, until both running belt gauges again read exactly 3%.
13. When both gauges again read 3% the belt is at its original tension. It will now be necessary to touch up the running belt tracking, however if this procedure was carefully followed, the belt tracking should be very close.
14. Remove both belt gauges from the running belt.
15. Start the treadmill and operate it at 2 m.p.h. Observe the running belt. If the belt drifts away from its centered position re-track it by adjusting the take up roller mounting bolts as described in step 16.

16. If the belt drifts to the right, slowly turn the right hand mounting bolt clockwise until the drifting stops. If the belt drifts to the left, slowly turn the left hand mounting bolt clockwise until the drifting stops. Only a very small adjustment should be required, 1/8 to 1/4 turn.
17. Increase the treadmill speed to 4 m.p.h., if the belt drifts away from center, touch up the tracking as described in step 18.
18. If the belt drifts to the right, slowly turn the left hand mounting bolt counter-clockwise until the drifting stops. If the belt drifts to the left, slowly turn the right hand mounting bolt counter-clockwise until the drifting stops. Only a very small adjustment should be required, 1/8 to 1/4 turn.
19. Increase the treadmill speed to 8 m.p.h., if the belt drifts away from center, track it as described in step 16.
20. Increase the treadmill speed to maximum, if the belt drifts away from center, track it as described in step 18.
21. Set the treadmill at a comfortable running speed and run on the treadmill for a couple of minutes and note the running belt tracking. If required track it as described in step 16. Replace the end caps and motor cover removed in step 3.

Procedure 6.13 - Take Up Roller Replacement

This procedure is to be used to replace a take up roller while maintaining the running belt's original tension and tracking settings. Two running belt gauges, Precor part number 20007-101, are required. It is important that this procedure be followed to maintain correct running belt tension. When tension is removed from the running belt, the belt requires 24 hours for it to "relax". If tension is removed from the belt and then re-tensioned without following this procedure or allowing a 24 hour relaxation period, the running belt may be over tensioned. Over tensioning the belt will lead to premature running belt wear, premature driver roller bearing failure and premature take up roller bearing failure.

1. Place two running belt gauges on each side of the running belt, being sure that the gauges are not across a belt seam. Set the gauges to the 3% mark as shown in the Illustration below.



2. Once set the belt gauges can not be disturbed or moved, doing so will invalidate the tension settings and necessitate a 24 hour relaxation period before the running belt can be re-tensioned.
3. Remove the end caps from the rear of treadmill to expose the take up roller mounting bolts.
4. If applicable, remove the finger guard located in front of take up roller.
5. Remove both take up roller mounting bolts. The belt gauge readings will decrease as the take up roller mounting bolts are removed. Remove the take up roller from the treadmill.

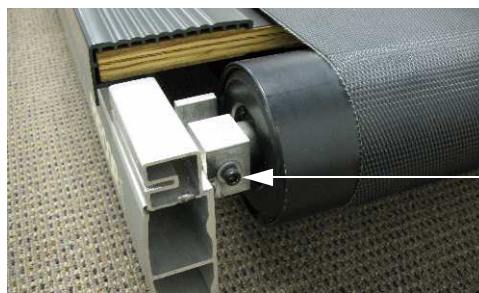

**Take Up Roller
Mounting Bolt**

6. Slide the replacement take up roller into the running belt and set it in its mounting position. Hand start both take up roller mounting bolts that were removed in step 5.
7. Alternate tightening the two take up roller mounting bolts, in order to tighten both ends evenly, until both running belt gauges again read exactly 3%.
8. When both gauges again read 3% the belt is at its original tension. It will now be necessary to touch up the running belt tracking, however if this procedure was carefully followed, the belt tracking should be very close.
9. Remove both belt gauges from the running belt.
10. Start the treadmill and operate it at 2 m.p.h. Observe the running belt. If the belt drifts away from its centered position re-track it by adjusting the take up roller mounting bolts as described in step 11.
11. If the belt drifts to the right, slowly turn the right hand mounting bolt clockwise until the drifting stops. If the belt drifts to the left, slowly turn the left hand mounting bolt clockwise until the drifting stops. Only a very small adjustment should be required, 1/8 to 1/4 turn.
12. Increase the treadmill speed to 4 m.p.h., if the belt drifts away from center, touch up the tracking as described in step 13.
13. If the belt drifts to the right, slowly turn the left hand mounting bolt counter-clockwise until the drifting stops. If the belt drifts to the left, slowly turn the right hand mounting bolt counter-clockwise until the drifting stops. Only a very small adjustment should be required, 1/8 to 1/4 turn.
14. Increase the treadmill speed to 8 m.p.h., if the belt drifts away from center, track it as described in step 11.
15. Increase the treadmill speed to maximum, if the belt drifts away from center, track it as described in step 13.
16. Set the treadmill at a comfortable running speed and run on the treadmill for a couple of minutes and note the running belt tracking. If required track it as described in step 11.
17. If applicable, replace the finger guard removed in step 4.
18. Replace the end caps removed in step 3.

Procedure 6.14 - Running Belt and/or Deck Replacement

This procedure is to be used to replace the running belt and/or deck while maintaining the drive belt's original tensioning and setting the running belt's tension and tracking. Two running belt gauges, Precor part number 20007-101, are required. It is important that this procedure be followed to maintain correct drive belt and running belt tension. Over tensioning the belt will lead to premature running belt wear, premature driver roller bearing failure and premature take up roller bearing failure. This procedure addresses decks that can be flipped, however it is important to note that only double sided decks can be flipped. Single sided decks must be replaced.

19. Remove the end caps from the rear of treadmill to expose the take up roller mounting bolts. Remove the treadmill's motor cover.
20. If applicable, remove the finger guard from in front of the take up roller.
21. Remove both take up roller mounting bolts. Remove the take up roller from the treadmill.

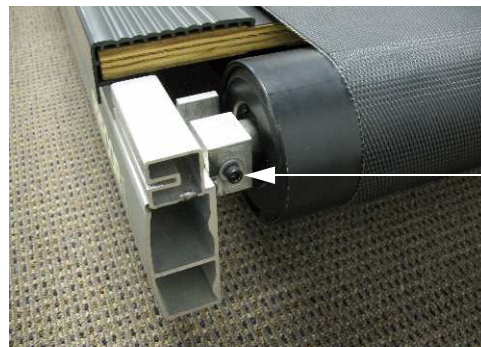

**Take Up Roller
Mounting Bolt**

22. Slowly rotate the drive motor flywheel while pressing the drive belt off of the drive roller pulley. Continue until the drive belt "walks" completely off of the drive roller pulley.

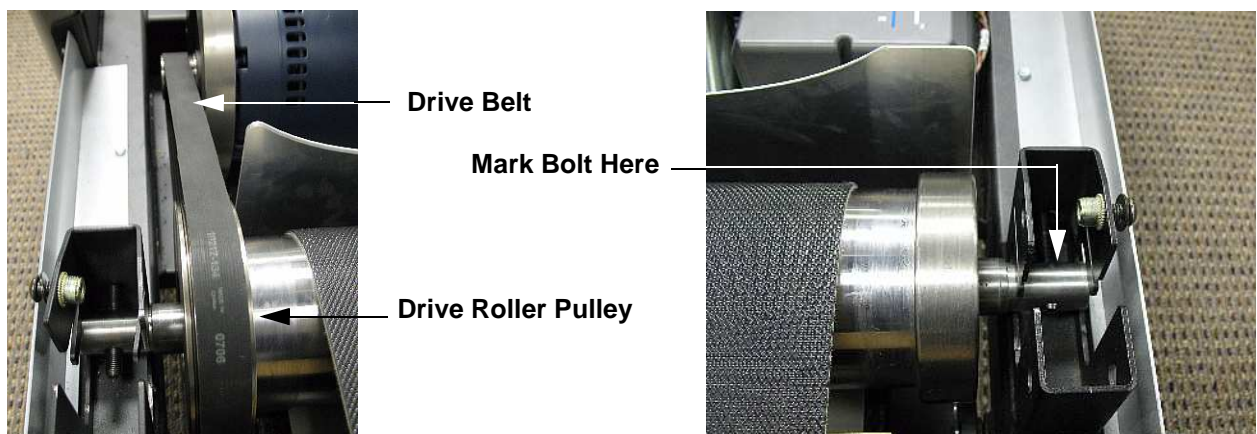

23. Using a fine tip marker or scribe, place a mark on the right hand drive roller mounting bolt directly in front of the drive roller shaft. The bolt is being marked so that the drive roller can be returned to the exact same position. The use of a fine marking line allows for more accuracy when the replacement drive roller is installed.

24. Remove both drive roller mounting bolts. Remove the drive roller from the treadmill.
25. Remove the running belt and deck from the treadmill. If both sides of the deck have been used, discard the deck. If the bottom side of the deck has not been used, flip the deck so that when it is replaced it will now be the top side.
26. Decks with inserts that are being flipped need to be reversed so that the bottom of the deck can be used, the inserts can be removed by threading the deck screw into the insert from the top. Using a hammer or mallet the insert can be tapped out the bottom of the deck. Remove the insert from the deck screw. Using one of the **CATN025-150** bolts and a flat washer, to cover the hole, thread the bolt into the insert and pull the insert into the opposite side of the deck until the insert is flush with the deck surface. Repeat this procedure with the remaining five inserts.
27. Using a clean, dry cloth, wipe the top surface of the deck clean of any dirt, dust or debris. Set the replacement or flipped deck inside of the replacement running belt. Set the running belt and deck combination in its mounting position on the treadmill.
28. Place two running belt gauges on each side of the running belt, being sure that the gauges are not across a belt seam. Set the gauges to the 3% mark as shown in the Illustration below

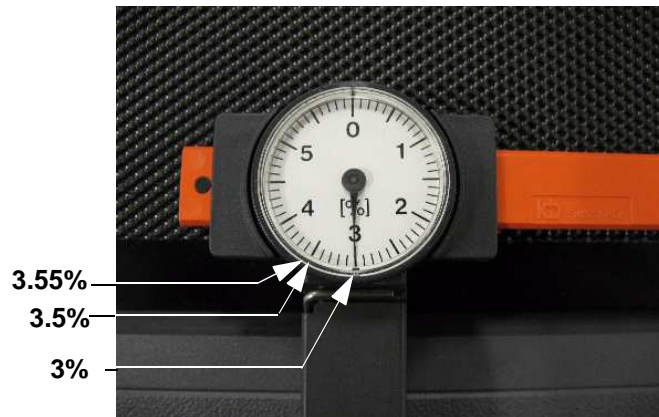
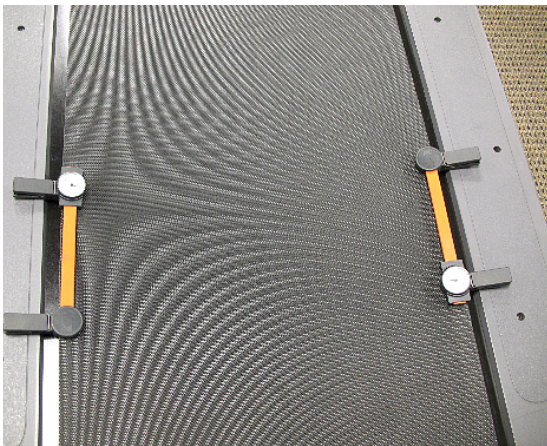

29. Slide the drive roller into running belt and into the drive belt. Hand start both drive roller mounting bolts.
30. Tighten the left hand drive roller bolt fully. The left hand side of the drive roller should be as far forward as possible.
31. Tighten the right hand drive roller bolt until the mark placed on it in step 5 aligns with the front edge of the drive roller shaft.
32. Steps 12 and 13 should place the drive roller into its original position and should now be square to the treadmill frame.

33. Slowly rotate the drive motor flywheel while pressing the drive belt onto of the drive roller pulley. Continue until the drive belt “walks” completely onto of the drive roller pulley. Be sure that the drive belt is fully onto and correctly aligned on the drive roller pulley.
34. Slide the take up roller into the running belt and set it in its mounting position. Hand start both take up roller mounting bolts that were removed in step 2.
35. Alternate tightening the two take up roller mounting bolts, in order to tighten both ends evenly, until both running belt gauges again read exactly 3.5% on consumer treadmills or 3.55% on commercial treadmills.
36. When both gauges again read 3.5 or 3.55% the belt is at its original tension. It will now be necessary to touch up the running belt tracking, however if this procedure was carefully followed, the belt tracking should be very close.
37. Remove both belt gauges from the running belt.
38. Start the treadmill and operate it at 2 m.p.h. Observe the running belt. If the belt drifts away from its centered position re-track it by adjusting the take up roller mounting bolts as described in step 21.
39. If the belt drifts to the right, slowly turn the right hand mounting bolt clockwise until the drifting stops. If the belt drifts to the left, slowly turn the left hand mounting bolt clockwise until the drifting stops. Only a very small adjustment should be required, 1/8 to 1/4 turn.
40. Increase the treadmill speed to 4 m.p.h., if the belt drifts away from center, touch up the tracking as described in step 23.
41. If the belt drifts to the right, slowly turn the left hand mounting bolt counter-clockwise until the drifting stops. If the belt drifts to the left, slowly turn the right hand mounting bolt counter-clockwise until the drifting stops. Only a very small adjustment should be required, 1/8 to 1/4 turn.
42. Increase the treadmill speed to 8 m.p.h., if the belt drifts away from center, track it as described in step 21.
43. Increase the treadmill speed to maximum, if the belt drifts away from center, track it as described in step 23.
44. Set the treadmill at a comfortable running speed and run on the treadmill for a couple of minutes and note the running belt tracking. If required track it as described in step 21.
45. If applicable, replace the finger guard removed in step 2.
46. Replace the end caps and motor cover removed in step 1.

Wiring Diagram 7.1 - 9.33i, 9.35i

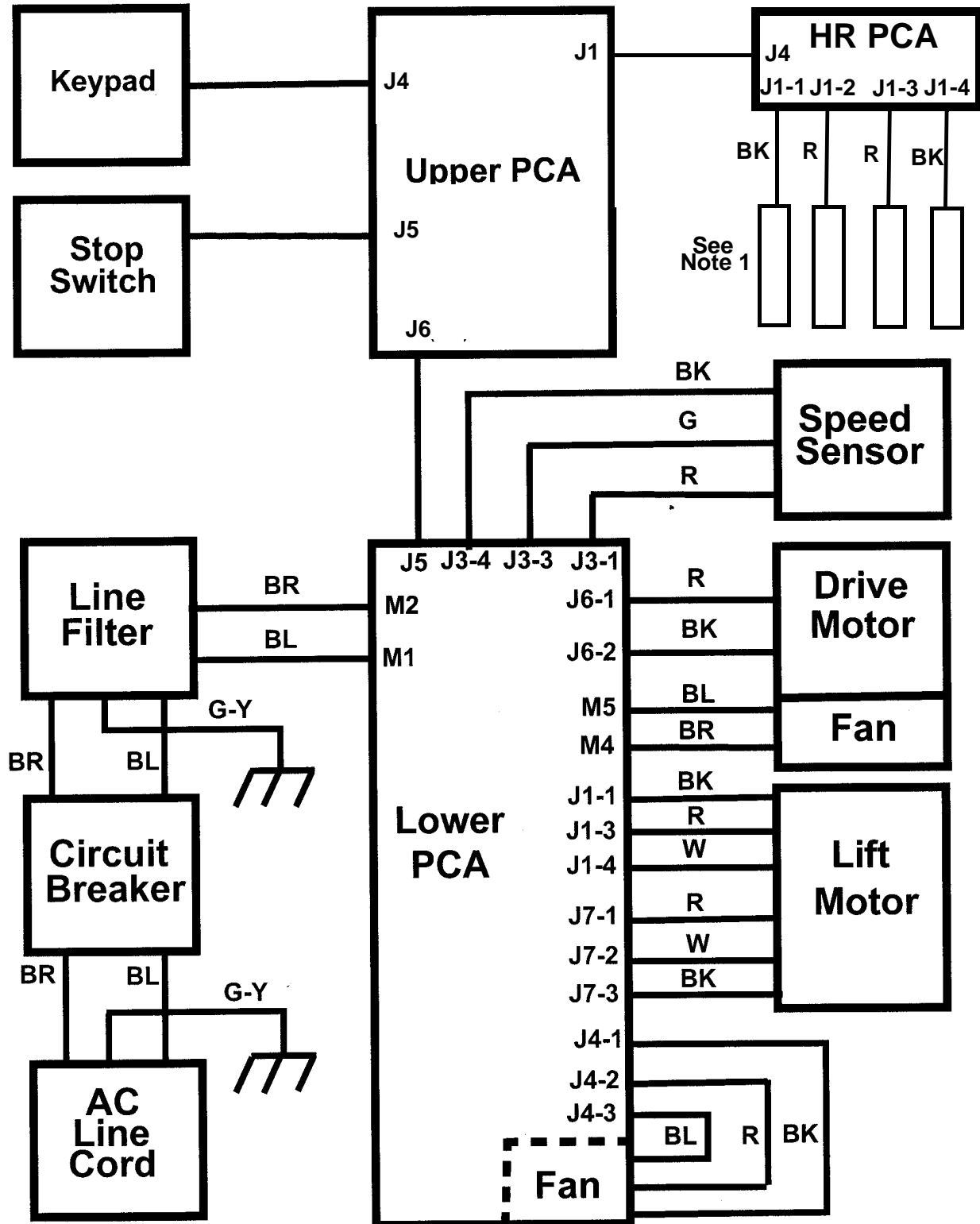

Note 1: HR PCA term J1-1 is connected to the left bottom grip, J1-2 to the left top grip, J1-3 to the right top grip and J1-4 to the right bottom grip

Block Diagram 7.2 - 9.33i, 9.35i



9.33i, 9.35i PWM Treadmill

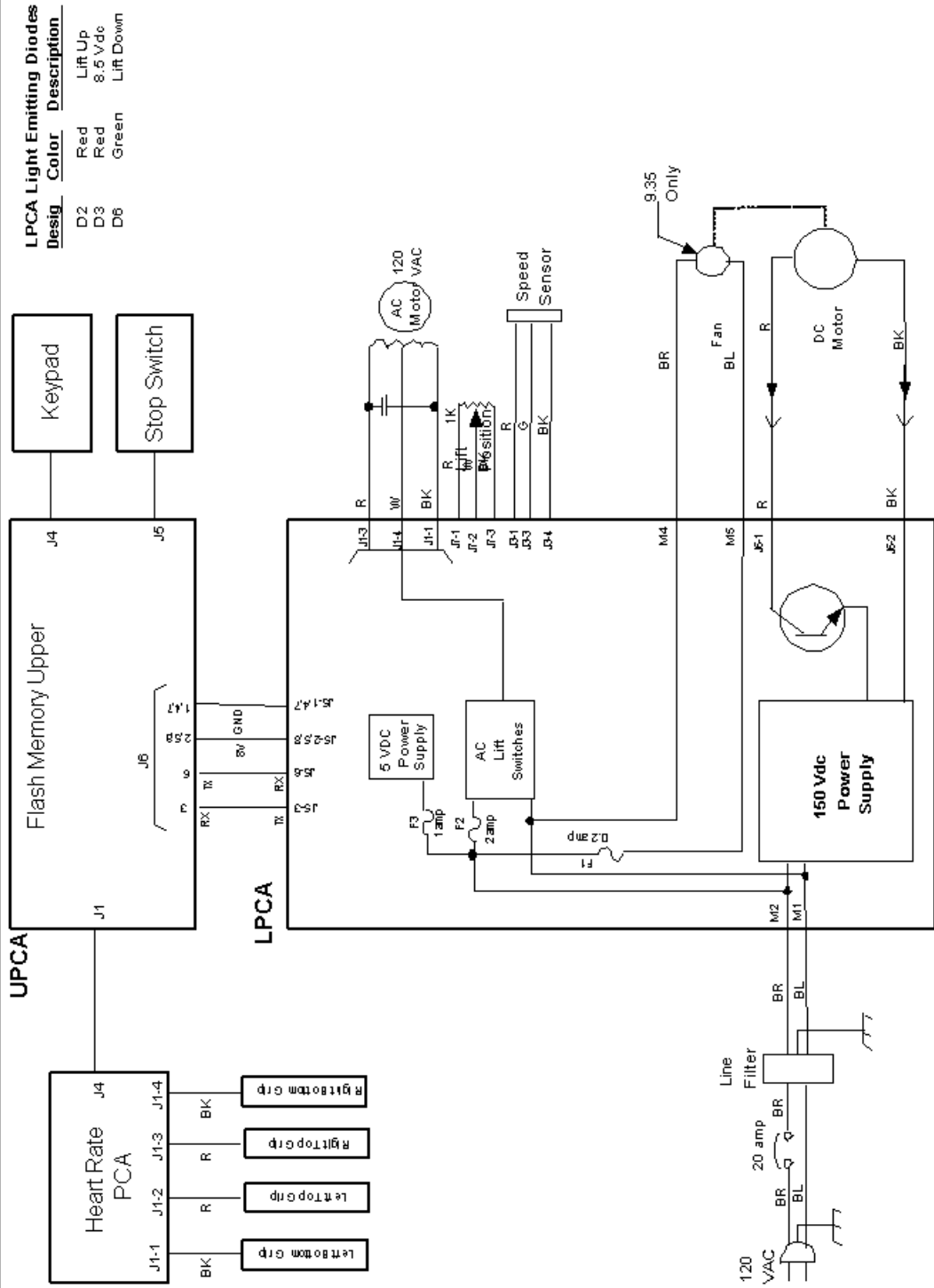

Design	Color	Description
D2	Red	Lift Up
D3	Red	8.6 Vdc
D6	Green	Lift Down